

Wiring Unlimited

Margreet Leeftink

Table of Contents

1. Introduction	1
1.1. Safety warnings	1
1.2. Disclaimer	1
1.3. Glossary of terms	1
2. Theory	2
2.1. Ohm's Law	2
2.2. Power	3
2.3. Conductivity and resistance	4
2.4. Electrical insulation	6
2.5. Connection resistance	6
2.6. Torque	7
2.7. Current, cable resistance and voltage drop	8
2.8. The negative effects of cable voltage drop	11
2.9. Ripple voltage	12
3. Battery bank wiring	15
3.1. The battery bank	15
3.2. Large battery banks	16
3.3. Parallel battery bank wiring	17
3.4. Lead-acid battery bank balancing	18
3.5. Battery bank midpoint	19
4. DC wiring	21
4.1. Cable selection	21
4.2. Busbars	24
4.3. Cable connections	26
4.4. Crimp terminals	29
4.5. Cable runs	30
4.6. Fuses and circuit breakers	31
4.7. DC isolation switches	35
4.8. Shunt	36
4.9. Parallel and/or 3-phase system DC wiring	37
4.10. Large system busbars	37
4.11. Voltage sensing and compensation	38
4.12. Solar	40
5. Communication wiring	44
5.1. Data signals	44
5.2. Interference	44
5.3. Communication cable types	45
5.4. Interfaces	47
6. AC wiring	49
6.1. Power generation	49
6.2. Distribution networks	49
6.3. System current, VA and Watts	50
6.4. AC cabling	52
6.5. AC fuses and circuit breakers	53
6.6. AC bypass switch	54
6.7. Special considerations AC wiring parallel inverter/charger systems	55
6.8. Phase rotation 3-phase inverter/charger systems	56
7. Ground, earth and electrical safety	57
7.1. Electrical safety	57
7.2. Earth wiring	58
7.3. RCD, RCCB or GFCI	58
7.4. Neutral to earth link in inverters and in inverter/chargers	60
7.5. Mobile installations	61
7.6. Isolation and grounding of Victron equipment	62
7.7. System grounding	63

8. Galvanic corrosion	66
8.1. Preventing galvanic corrosion	66
8.2. The galvanic isolator	67
8.3. The isolation transformer	67
9. Credits	68

1. Introduction

Welcome to "Wiring unlimited", a book about electrical wiring systems containing batteries, inverters, chargers and inverter/chargers.

With this book, we aim to explain the wiring basics of electrical systems. We will explain the importance of "getting it right" and cover the issues that might result if a system has bad wiring. It also assists electrical installers or users in troubleshooting issues that have arisen from bad wiring so that a correct conclusion can be drawn for the electrical systems they are involved with.

Wiring issues are often a cause of system problems, or they can lead to the underperformance of systems.

For a trouble-free operation of any electrical system, particularly those that contain an inverter/charger and batteries, which are "high-current" devices, it is essential that the system's wiring is done correctly.

This book will help you with "getting it right".

1.1. Safety warnings

Electricity is dangerous. It can cause harm to persons or property.

It takes a remarkably small amount of current across the human heart to stop it. Due to the natural resistance of the human skin and tissue, this means that a high voltage is required to generate this heart-stopping current, but humans have died from voltages as low as 42 Volts.

Both DC and AC can cause this fatal occurrence. Electrical work should, therefore, always be carried out by a qualified electrician or technician and the local safety guidelines and requirements need to be adhered to.



IMPORTANT:

- AC and DC voltages are dangerous and harmful.
- Always use insulated tools when working with electricity and batteries.
- Do not short-circuit batteries. This can cause fire or explosion.
- Battery charging can create explosive gasses.
- Undersized wiring or bad electrical contact can cause a fire.
- Always refer to the safety warning in the appropriate product manuals.

1.2. Disclaimer

The sole purpose of this document is to aid in understanding the basic principles behind certain electrical concepts. This document is intended as a guide only.

Electrical wiring regulations can differ based on where you are in the world. Your local electrical regulations can vary from the wiring advice given in this document.

You are responsible for always seeking professional advice and instruction from local authorities and/or licensed electricians before undertaking any electrical work.

1.3. Glossary of terms

This book utilises the metric system and all units, and shorthand notations align with the International System of Units (SI). For more information on the International System of Units see this link: https://en.wikipedia.org/wiki/International_System_of_Units

2. Theory

You will get the most out of this book if you have knowledge of basic electrical theory. This will help you to understand the underlying factors that determine wiring thickness and fuse ratings. You might already have this basic understanding and can perhaps skip this chapter, but we highly recommend that you read this chapter.

2.1. Ohm's Law

Ohm's law is the most important law of an electric circuit. It is the basis of almost all electrical calculations. It allows you to calculate the current that runs through a cable (or a fuse) at different voltages. Knowing how much current runs through a cable is essential knowledge to be able to choose the correct cable for your system. But first, some basic knowledge about electricity is needed.

What is electricity:

Electricity is the movement of electrons in a material, called a conductor. This movement creates an electric current. This current is measured in "Ampere" (amps for short) and the symbol is the letter A.

The force required to make the electrons flow is called voltage (or potential). It is measured in "Volt" and the symbol is the letter V (In Europe also referred to as U).

When an electrical current passes through a material, it meets a certain resistance. This resistance is measured in Ohm. The symbol is Ω .

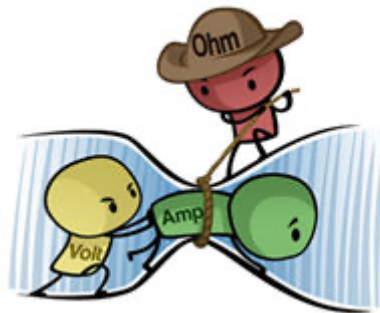

How do voltage, current and resistance relate to each other:

- When the resistance is low, many electrons move, and the current is high.
- When the resistance is higher, fewer electrons move, and the current is lower.
- When the resistance is very high, no electrons move at all, and the current has stopped.

Ohm's law:

You can say that the resistance of a conductor determines how much current runs through a material at a given voltage. This can be represented in a formula. The formula is called Ohm's Law:

$$\text{Current (A)} = \text{Voltage (V)} / \text{Resistance } (\Omega)$$

$$I = V/R$$

2.2. Power

Ohm's law describes the relationship between resistance, current and voltage. But there is one more electrical unit that can be derived from Ohm's law, and this is power.

Power is an expression of how much work an electric current can do. It is measured in Watts, and the symbol is P. It can be calculated using the following formula:

$$P = I \times V$$

From Ohm's law, other formulas can be derived as well. All possible formulas are listed in the below image. Please note that there are two symbols in use in the world that represent voltage. These are U or V.

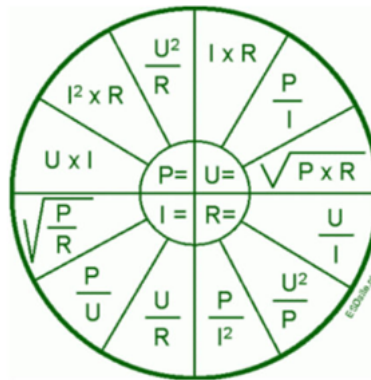

Some of these formulas are very useful when calculating the current in a cable. One often used formula is:

$$I = P/V$$

This formula can calculate how much current runs through a cable when the voltage and the power are known.

An example of how this formula can be used:

Question:

- If we have a 12V battery that is connected to a 2400W load. How much current is running through the cable?

Answer:

- $V = 12V$
- $P = 2400W$
- $I = P/V = 2400/12 = 200A$

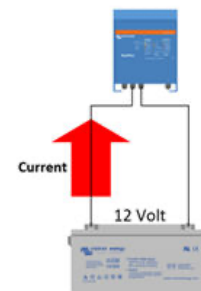

The benefits of using power instead of current in calculations:

A big advantage of using power in calculations or for measurements is that power is independent of voltage. This is useful in systems where multiple voltages exist. An example of this would be a system with a DC battery, AC power and perhaps a solar panel with a different DC voltage than the battery.

Power remains the same across the different voltages. For example, if you run an AC load of 2400W via an inverter from a 12V battery, it will also take 2400W from the battery (ignoring the inverter inefficiencies).

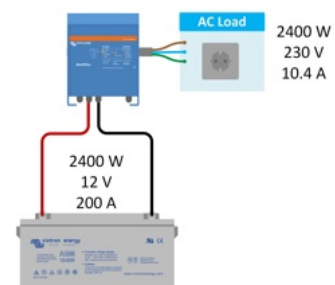

2.3. Conductivity and resistance

Some materials conduct electricity better than other materials. Materials with a low resistance conduct electricity well, and materials with a high resistance conduct electricity poorly or not at all.

Metals have a low resistance, and they conduct electricity well. These materials are called conductors. This is the reason they are used as the core in electrical cables.

Plastic or ceramics have a very high resistance, they do not conduct electricity at all. They are called insulators. This is why non-conductive materials, like plastic or rubber, are used on the outside of cables. You will not get an electrical shock when you touch the cable because electricity cannot travel through this material. Insulators are also used to prevent a short-circuit should two cables touch each other.

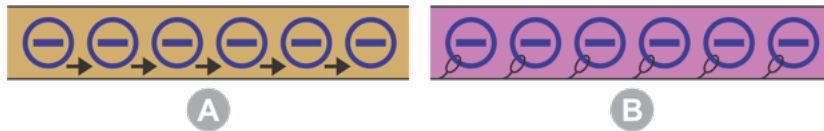

A: In a conductor, the electrons are able to move.

B: In an insulator, the electrons are not able to move or move very slowly.

Each material has its own specific resistance. It is measured in $\Omega \cdot m$ and the symbol is ρ (rho). The below table lists various conducting materials, their electrical conductivity and their specific resistance. As you can see in this table, copper conducts electricity well and has a low resistance. This is the reason why electrical cable is made from copper. But, for example, titanium does not conduct electricity well and therefore has a higher specific resistance. Titanium is not very suitable as an electric conductor.

Material	Electrical conductivity (10.E6 Siemens/m)	Electrical resistivity (10.E-8 Ohm.m)
Silver	62.1	1.6
Copper	58.5	1.7
Gold	44.2	2.3
Aluminium	36.9	2.7
Molybdenum	18.7	5.3
Zinc	16.6	6.0
Lithium	10.8	9.3
Brass	15.9	6.3
Nickel	14.3	7.0
Iron	10.1	9.9
Palladium	9.5	10.5
Platinum	9.3	10.8
Tungsten	8.9	11.2
Tin	8.7	11.5
Bronze	7.4	13.5
Carbon steel	5.9	16.9
Lead	4.7	21.3
Titanium	2.4	41.7

There are two more factors that determine cable resistance. These are the length and the thickness of the conductor (cable):

These factors relate in the following way:

- A thin cable has a higher resistance than a thick cable of the same length.
- A long cable has a higher resistance than a short cable of the same thickness.

The resistance of a length of cable can be calculated by the following formula:

$$\text{Resistance} = \text{Rho} \times \text{length} / \text{Area}$$

$$R = \rho \times l / A$$

As in the above formula, there are 3 factors that determine cable resistance. Namely:

- The electrical resistance of the material used.
- The length of the cable, a longer cable equals more resistance.
- The diameter of the cable, a thinner cable equals more resistance.

It is important to know the resistance of a cable because when a current passes through a cable, the cable resistance is responsible for these two effects:

- There will be a voltage drop (loss) over the cable length.
- The cable heats up.

If the current increases, these effects will worsen. An increased current will increase the voltage drop and the cable will heat up more.

An example how to calculate the resistance of a cable:

Question:

- What is the resistance of a 1.5-meter, 16mm² cable?

Given:

- ρ copper = $1.7 \times 10^{-8} \Omega/\text{m}$
- $l = 1.5\text{m}$
- $A = 16 \text{ mm}^2 = 16 \times 10^{-6} \text{ m}^2$

Answer:

- $R = \rho \times l / A$
- $R = 1.7 \times 10^{-8} \times 1.5 / (16 \times 10^{-6})$
- $R = 1.7 \times 10^{-2} \times 1.5 / 16$
- $R = 0.16 \times 10^{-2} = 1.6 \times 10^{-3}$
- $R = 1.6\text{m}\Omega$

The effect of cable length:

Let's use the previous example and now calculate for a 5-meter cable. The result will be that the resistance is 5.3mΩ. If you make the cable longer, the resistance will increase.

The effect of cable thickness:

Let's take the original example and now calculate for a cable with a cross-section of 2.5mm². The result will be that the resistance is 10.2mΩ. If you make the cable thinner, the resistance will increase.

Conclusion:

Both cable thickness and cable length have a big impact on cable resistance.

2.4. Electrical insulation

Electrical insulators are used to prevent the flow of electrical current from one part of an electrical circuit to another and to protect people and equipment from electric shock.

As we saw in the table in the previous chapter, if a material does not conduct electricity well, it is called an insulator.

Examples of electrical insulators include rubber, plastic, glass, ceramics, and air. These materials are used in various electrical applications, such as insulation for wires, insulators for electrical equipment, and coatings for electrical components.

Electrical insulators play a critical role in ensuring the safe and efficient operation of electrical systems and in preventing electrical hazards.

As a rule of thumb, the higher the voltage, the thicker or better the insulation needs to be. This is why, for example, special cables are required to and from a high-voltage solar array.

Insulated cables and electrical tools are rated for a specific maximum voltage. Ensure that this voltage rating matches your application.

2.5. Connection resistance

Resistance in an electrical installation is not solely determined by the resistance of the cable, as the resistance of the electrical connections also contributes to the total resistance.

How is connection resistance created:

Whenever a connection is made between a cable and an appliance or between a cable and a cable terminal the resistance of the circuit increases. The degree of resistance is influenced by the quality of the connection and the size of the connecting area.

- A tight connection will have less resistance than a loose connection.
- A large connection area will have less resistance than a small connection area.

How to limit connection resistances:

- Make tight and secure connections. Ensure that connectors are fastened correctly while not exceeding the maximum torque. For more information, see the [Torque \[7\]](#) chapter.
- In case of a nut or bolt connection, always add a washer and spring washer in the correct order, as indicated in the image on the right.
- Correctly crimp cable terminals to a cable. Use an appropriate crimping tool and use a correctly sized cable terminal. For more information, see the [Crimp terminals \[29\]](#) chapter:

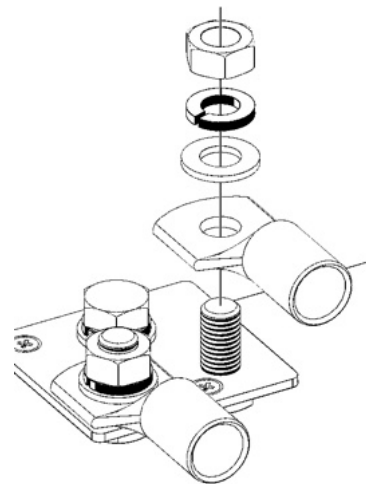

Be aware that resistance will also create heat:

A poor connection with high resistance will generate excessive heat. The relationship between power, current, and resistance is described by the formula $P = I^2R$. In extra-low voltage DC, even a small amount of resistance can result in a dangerous level of heat that can cause equipment and cables to become damaged, or even cause a fire in severe cases.

2.6. Torque

As described in the previous chapter, it is important to make tight electrical connections, as loose connections will lead to resistance, heat and potential corrosion due to arcing. But also be aware not to over-tighten these connections, as damage to the connector fastener might occur.

Electrical connection fasteners, screws or bolts are often made of tin-plated brass. It is a common misconception to assume that these fasteners are made of stainless steel with over-tightening and damage to the fastener as a result.

Always use a torque wrench (or torque screwdriver), so you know the bolt or screw is tightened correctly.

Note that our products have metric connection bolts, commonly used threads are M4, M5, M6, M8 and M10, and the recommended torque values in our documentation are in listed in N.m (Newton.meter).



Insulated torque screwdriver.



Insulated torque wrench.

How to correctly use a torque wrench

To use a torque wrench, follow these steps:

1. Choose the correct torque setting as per the manual. The torque wrench should have a scale or dial that can be adjusted to the desired torque value.
2. Place the torque wrench on the fastener (bolt, nut or screw).
3. Use the torque wrench to apply force to the fastener, turning it until you reach the desired torque setting.
4. The torque wrench will typically click or give some form of indication when the desired torque setting has been reached. Double-check the torque value with a torque-checking device if available.



Note that it is important to follow the manufacturer's instructions and guidelines when using a torque wrench to ensure accuracy and prevent damage to the tool or the equipment being worked on.

The maximum torque for brass bolts can vary based on factors such as the type of brass, the size and length of the bolt, and the intended use. In general, the maximum torque for brass bolts is lower than for steel bolts of the same size.

Normally the product manual will state the correct maximum torque moment for the electrical connections. But if this information is missing, use the below table for brass bolts, nuts or screws.

Maximum torque values for brass fasteners:

Thread	Maximum torque in N.m	Equivalent in lbf.ft	Equivalent in lbf.in
M3	0.5	0.4	4.4
M4	1.0	0.7	8.9
M5	2.0	1.5	17.7
M6	3.0	2.2	26.6
M8	5.0	3.7	44.3
M10	9.0	6.6	79.7



Note that these are rough estimates and may vary based on the specific application, so it is important to consult the product manual or engineering guidelines to determine the appropriate torque value. Over-torquing a bolt can lead to damage or failure of the bolt or the components being fastened.

2.7. Current, cable resistance and voltage drop

A low voltage results in a high current:

As already explained, the current that flows through an electrical circuit for a fixed load is different for a variety of circuit voltages. The higher the voltage, the lower the current will be.

Below is an overview of the amount of current that flows in three different circuits where the load is the same, but the battery voltage in each circuit is different:

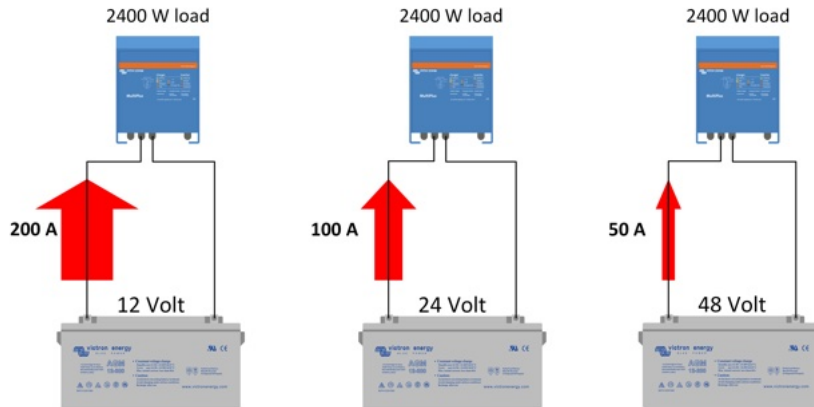

Cable resistance creates a voltage drop over the cable:

Also, as explained already, a cable has a certain amount of resistance. The cable is part of the electrical circuit and can be treated as a resistor.

When current flows through a resistor, the resistor heats up. The same happens in a cable; when current flows through a cable, the cable heats up and, power is lost in the form of heat. These losses are called cable losses. The lost power can be calculated with the following formula:

$$\text{Power} = \text{Resistance} \times \text{Current}^2$$

$$P = R \times I^2$$

Another effect of cable loss is that a voltage drop will be created over the length of the cable. The voltage drop can be calculated with the following formula:

$$\text{Voltage} = \text{Resistance} \times \text{Current}$$

$$V = R \times I$$

The 1st and 2nd law of Kirchhoff:

To be able to calculate the effect of a cable voltage drop, you will need to know two more electric laws, namely the first and second law of Kirchhoff:

Kirchhoff's current law (1st law):

The current flowing into a junction must be equal to the current flowing out of it.

An example of this is a parallel circuit. The voltage over each resistor is the same while the sum of current flowing through each resistor equals the overall current.

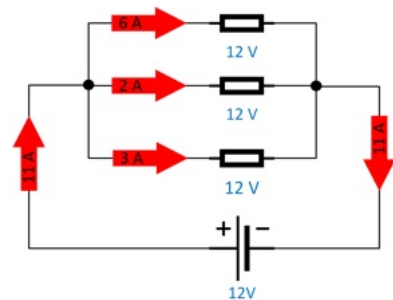

Kirchhoff's voltage law (2nd law):

The sum of all voltages around any closed loop in a circuit must equal zero.

Here the exact opposite is the case. In a series circuit, the current through each resistor is the same, while the sum of the voltages over each resistor equals the overall voltage.

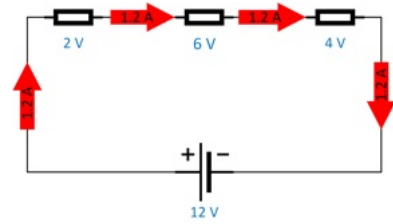

Voltage drop calculation example:

Now, let's use a real-world example of an inverter that is connected to a 12V battery and calculate the cable losses. In the circuit diagram on the right, you find a 2400W inverter connected to a 12V battery using two 1.5-meter-long, 16 mm² cables.

As we calculated earlier, each cable has a resistance of 1.6mΩ. Knowing this, we can now calculate the voltage drop over one cable:

- A 2400W load at 12V creates a current of 200A.
- The voltage drop over one cable is: $V = I \times R = 200 \times 0.0016 = 0.32V$.
- Since there are two cables, the positive and the negative cable, the total voltage loss in this system is 0.64V.
- Because of the 0.64V voltage drop, the inverter does not get 12V anymore, but $12 - 0.64 = 11.36V$.

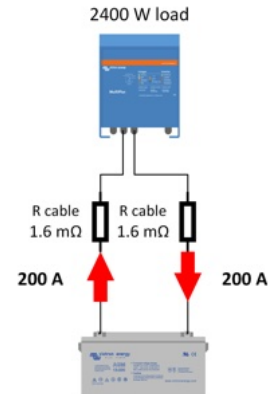

The power of the inverter is constant in this circuit. So, when the voltage to the inverter drops, the current will increase. Remember $I = P/V$.

The battery will now deliver more current to compensate for the losses. This means, in the earlier example, that the current will increase to 210A.

This makes the system inefficient because we now have lost 5% (0.64/12) of the total energy. This lost energy has been turned into heat.

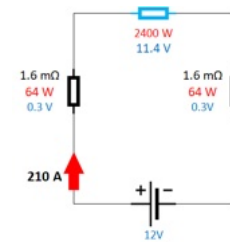

How to reduce voltage drop:

It is important to keep the voltage drop as low as possible. The obvious way to do that is to increase the thickness of the cable or to keep the cable length as short as possible. But there is something else you can do. This is to increase the voltage of the electric circuit. The cable voltage drop varies for different battery (system) voltages. Generally speaking, the higher the voltage of the circuit, the lower the voltage drop will be.

Example:

If we look at the same 2400W load, but now the system voltage is 24 or 48V:

- The 2400W load at 24V will create a current of $2400/24 = 100A$.
- The total voltage drop will be $2 \times 100 \times 0.0016 = 0.32V$ (= 1.3%).
- And at 48V the current will be 50A. The voltage drop is 0.16V (= 0.3%).

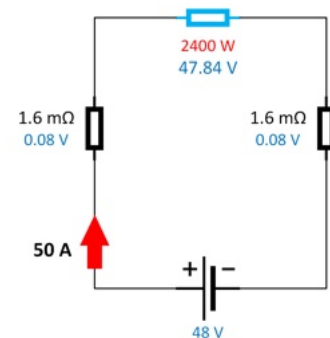
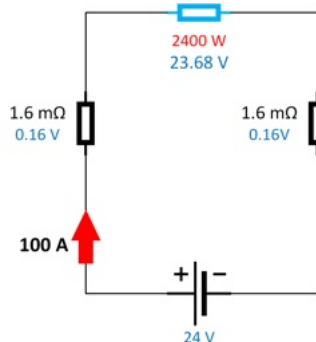
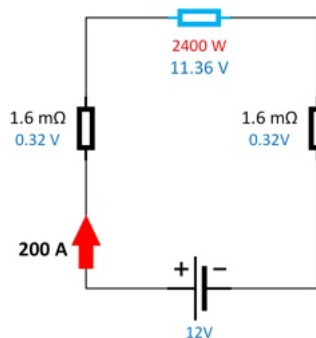

How much voltage drop is allowed?

This leads to the next question; how much voltage drop is allowed? The opinions vary somewhat, but we advise aiming for a voltage drop no bigger than 2.5%. This is indicated in the below table for the different voltages:

System voltage	Percentage	Voltage drop
12V	2.5%	0.3V
24V	2.5%	0.6V
48V	2.5%	1.2V

Not just the cable resistance, but other factors create resistance as well:

It is important to realise that resistance does not only occur in the cable itself. Additional resistance is created by any items in the path the current has to flow through.

A list of possible items that can add to the total resistance:

- Cable length and thickness.
- Fuses.
- Shunts.
- Switches or circuit breakers.
- The quality and suitability of the cable terminals and how well they have been crimped to the cable.
- The quality and tightness of all electrical connections.

And especially watch out for:

- Loose connections.
- Dirty or corroded contacts.
- Bad cable lug crimps.

Resistance will be added to the electrical circuit each time a connection is made, or if something is placed in the path between the battery and the inverter.

A list of possible items that can add to the total resistance:

- Each cable connection: 0.06mΩ.
- A 500A shunt: 0.10mΩ.
- A 150A fuse: 0.35mΩ.
- A 2-meter 35mm² cable: 1.08mΩ.

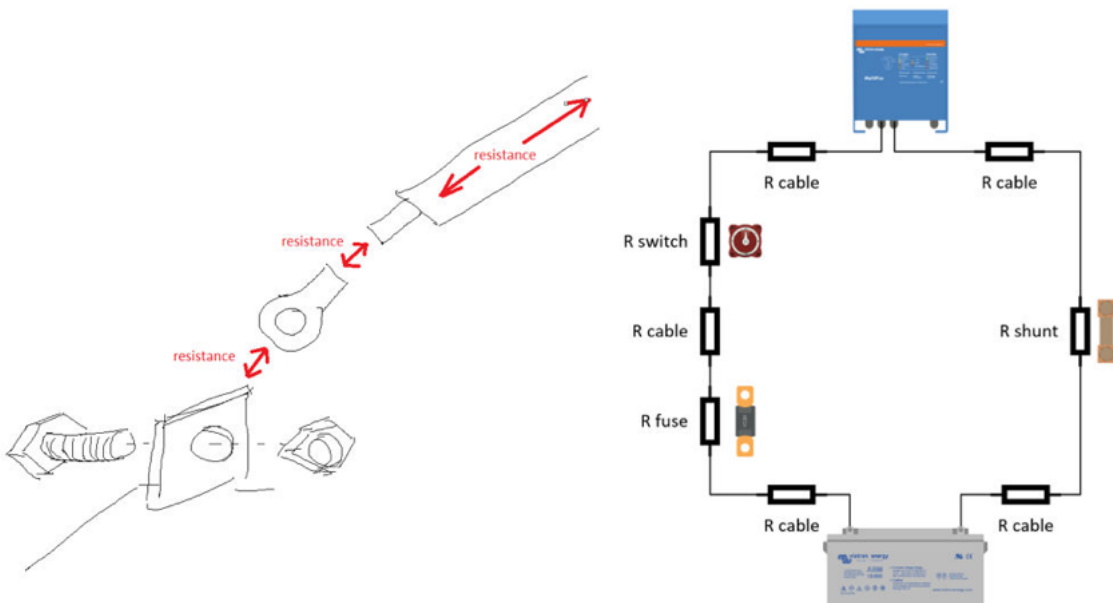

2.8. The negative effects of cable voltage drop

We now know what we need to do to keep resistance in a circuit low in order to prevent a voltage drop. But what are the negative effects if there is a high voltage drop in a system?

These are the negative effects of a high voltage drop:

- Energy is lost, and the system is less efficient. Batteries will be discharged quicker.
- The system current will increase. This can lead to DC fuses blowing.
- High system currents can lead to premature inverter overloads.
- Voltage drop during charging will cause batteries to be undercharged.
- The inverter receives a lower battery voltage. This can potentially trigger low-voltage alarms.
- The battery cables heat up. This can cause melting wiring insulation or cause damage to the cable conduits or to the connected equipment. In extreme cases, cable heating can cause a fire.
- All the equipment that is connected to the system will have a reduced lifetime.

This is how to prevent voltage losses:

- Keep cables as short as possible.
- Use cables with sufficient cable thickness.
- Make tight connections, but not too tight. Follow the torque recommendations in the manual.
- Check that all contacts are clean and not corroded.
- Use quality cable lugs and crimp these with the appropriate tool.
- Use quality battery isolation switches.
- Reduce the number of connections within a cable run.
- Use DC distribution points or busbars.
- Follow wiring legislation.

It is good practice to measure the system voltage drop once you have completed an electrical installation that contains batteries. Remember that a voltage drop typically occurs during a high current event. The voltage drop becomes larger when the current increases. This is the case when an inverter is loaded with maximum load or when a battery charger is charging at full current.

How to measure voltage drop, for example, in a system with an inverter:

- Load the inverter with maximum power.
- Measure the voltage across the negative cable between the inverter connection and the battery pole.
- Repeat this for the positive cable.

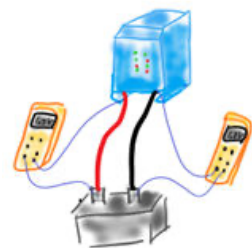

How to measure voltage drop when the battery is too far away or in a different room or enclosure:

- Load the inverter with maximum power.
- Measure the voltage across the DC connections inside the inverter.
- Measure the voltage across the battery poles
- Compare these readings. The difference between the two readings is the voltage drop.



2.9. Ripple voltage

One of the negative effects of a high voltage drop in a system is ripple.

Ripple occurs in systems with an inverter:

Ripple appears in a system where the power source is a battery (DC) and the load is an AC device. This is always the case in a system with an inverter. The inverter connects to batteries, but it powers an AC load.

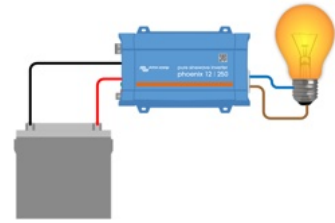

Voltage drop is the mechanism behind ripple:

The mechanism that causes ripple is directly related to the voltage drop over the DC cables when a system is under load, and the battery currents are high. A high current causes a high voltage drop, this becomes particularly exaggerated when thin cables have been used.

The voltage drop in a system as a whole can be even bigger, especially if lead acid batteries are used that are too small, too old or damaged. The voltage drop will not only occur over the cables but also within the battery itself. Ripple is related to the phenomenon that when an inverter is powering a large load, the system DC voltage drops. But the system voltage recovers once the load has been turned off. This process is depicted in the below image.

1. The voltage measured at the inverter is normal. In this example it is 12.6V.
2. When a large load is turned on, the battery voltage drops to 11.5V
3. When the load is turned off, the battery voltage usually recovers back to 12.6V

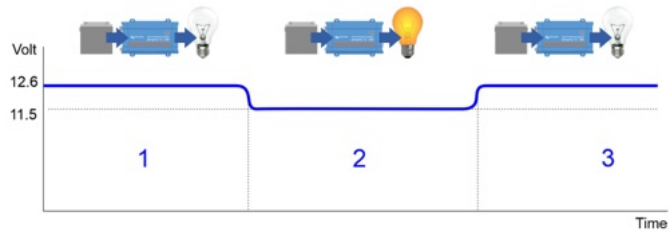

How is ripple created?

The following steps follow the sequence of how ripple is created:

1. The inverter converts a DC voltage into an AC voltage.

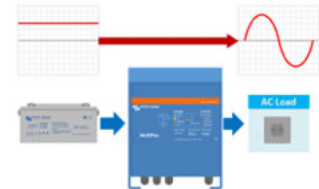

2. The load connected to the inverter creates an AC current in the inverter.

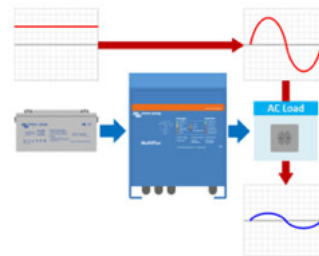

3. This AC current causes (via the inverter) a fluctuating DC current on the battery.

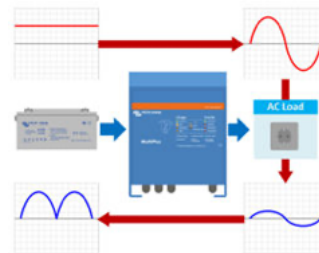

4. The result of this fluctuating DC current is the following:

- When the DC current peaks the battery voltage will drop.
- When the DC current drops the battery voltage recovers
- When the DC current peaks the battery voltage will drop again.
- And so on and so forth.

The DC voltage will keep going up and down and is not constant anymore. It now is fluctuating. It will go up and down 100 times per second (100Hz). The amount the DC voltage is fluctuating is called ripple voltage.

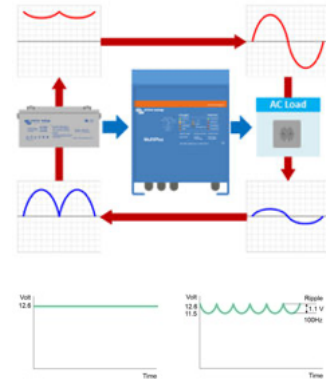

How to measure ripple:

When measuring ripple, remember that this only occurs when the system is under full load. Ripple can only be detected when the inverter is powering a full load or when a charger is charging at a high current. The same applies when measuring the voltage drop,

Ripple can be measured in these two ways:

- Use a multimeter. Select AC mode on the multimeter. Measure across the inverter's DC connections. You are now measuring the AC component of the DC voltage. This AC voltage is the ripple voltage.
- Use VEConfigure, it keeps track of ripple.

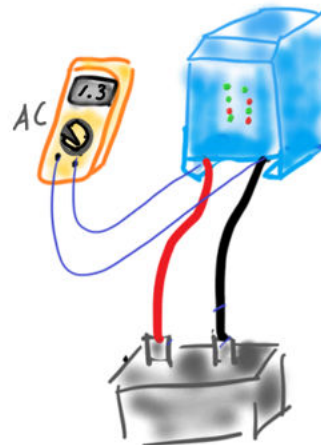
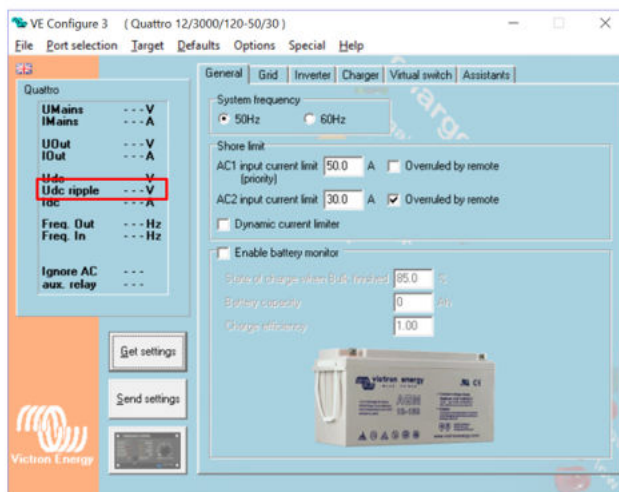

The negative impacts of ripple:

A small amount of ripple can exist with no measurable impact. However, excessive ripple can have a negative impact.

The negative impact of excessive ripple:

- The lifetime of the inverter will be reduced. The capacitors in the inverter will try to flatten the ripple as much as possible and as a result, the capacitors will age faster.
- The lifetime of the other DC equipment in the system will be reduced as well. They too suffer from ripple in the same way inverters do.
- The batteries will age prematurely. Each ripple acts as a mini cycle for the battery and the battery lifetime will reduce due to the increase in the number of battery cycles.
- Ripple during charging will reduce the charge power. It will take longer for the batteries to charge.

Ripple alarms:

Inverters or inverter/chargers have a built-in ripple alarm. There are two ripple alarm levels:

- **Ripple pre-alarm:** Both the overload and the low battery LEDs blink and the unit will turn off after 20 minutes.
- **Full ripple alarm:** Both the overload and low battery LEDs are on and the unit powers down.

These are the ripple alarm levels for inverter/charger models at the different DC voltages and the MultiPlus Compact regardless of voltage:

System voltage	Ripple pre-alarm (20 min) *	Ripple full alarm (3 sec) *	Charge regulation
12V	1.50V	2.50	1.4
24V	2.25V	3.75	2.1
48V	3.00V	5.00	2.8
MultiPlus Compact only (regardless of DC voltage)	1.50V	2.5V	0.8V

*) All voltages are RMS voltages.

How to fix ripple:

Ripple will only occur when there is a voltage drop in a system. To fix ripple voltage issues, you will have to reduce the voltage drop. This means that you have to reduce the resistance in the path from the battery to the inverter and back to the battery. For more information, see the [Current, cable resistance and voltage drop \[8\]](#) chapter.

To fix high ripple in a system do the following:

- Reduce long battery cables
- Use thicker cables.
- Check fuses, shunts and battery isolation switches for connectivity.
- Check the specifications of the fuses, shunts and battery isolation switches.
- Check for loose terminals and loose cable connections.
- Check for dirty or corroded connections.
- Check for bad, old or too small batteries.
- Always use good quality system components.

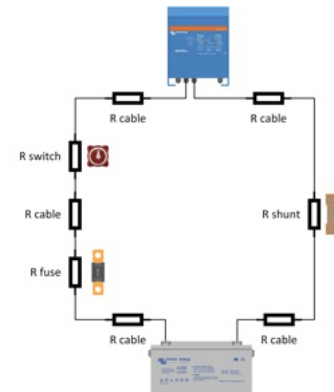

3. Battery bank wiring

At the heart of any Victron system sits the battery. This is either a single battery or a number of interconnected batteries.



CAUTION: Battery terminals are not insulated. To prevent short circuits or electric shock use insulated tools and do not wear metallic jewellery,

3.1. The battery bank

Batteries are interconnected to increase the battery voltage or to increase the battery capacity or both. Multiple interconnected batteries are called a battery bank.

The following applies to battery banks:

- When batteries are connected in series, the voltage increases.
- When batteries are connected in parallel, the capacity increases.
- When batteries are connected in series/parallel, both the voltage and the capacity increase.

Some examples:



Single battery.



Two batteries in series.

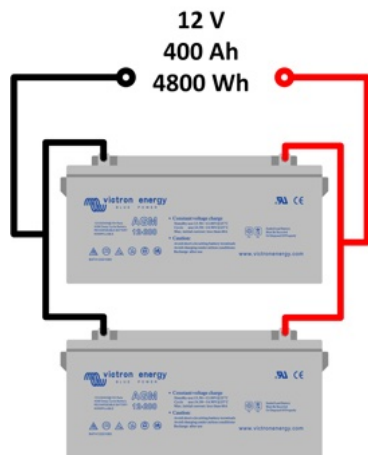

Two batteries in parallel.

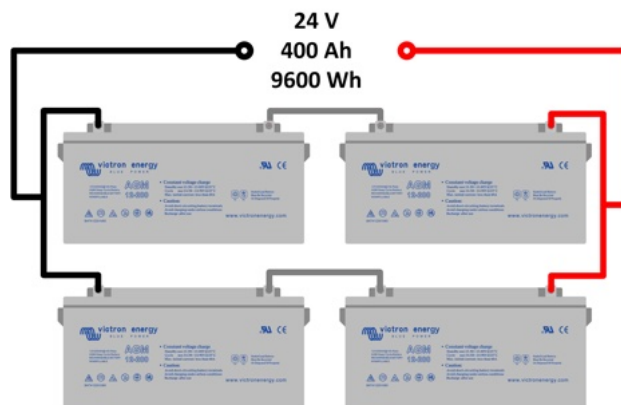

Four batteries in series/parallel.

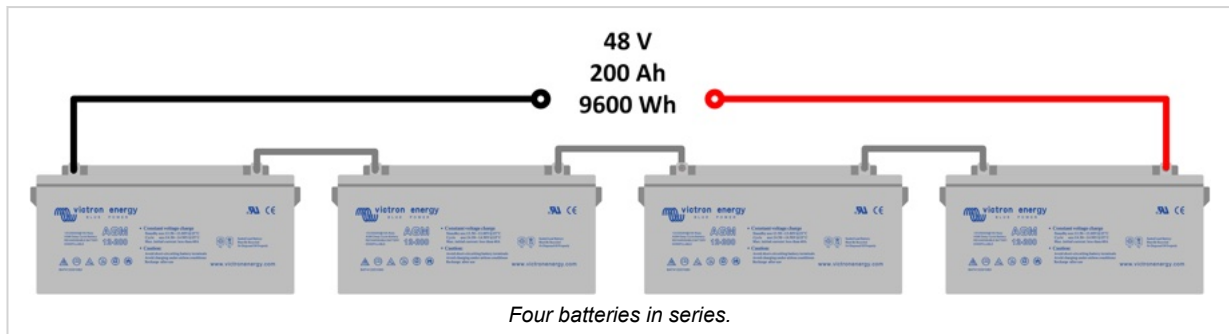

3.2. Large battery banks

If a large battery bank is needed, we do not recommend that you construct the battery bank out of numerous series/parallel 12V lead acid batteries. The maximum is at around 3 (or 4) paralleled strings. The reason for this is that with a large battery bank like this, it becomes tricky to create a balanced battery bank. In a large series/parallel battery bank, an imbalance is created because of wiring variations and slight differences in battery internal resistance.

Examples of large battery banks containing 2V lead acid batteries or lithium batteries:

2V lead acid batteries:

2V OPzV or OPzS batteries are available in a variety of large capacities. You only have to pick the capacity you want and connect them in series. They are supplied with dedicated connection links exactly for that purpose.



2V OPzV lead acid batteries and connection links.



Victron Energy lithium Battery Smart:

The lithium Battery Smart batteries have internal cell balancing and an external battery management system (BMS).



Lithium Battery 12,8V & 25,6V Smart



Smart Lithium batteries:

With cell balancing and internal or external battery management system (BMS). Each battery has the ability to communicate with each other, but they can also communicate with a monitoring device. In Victron's case, this is a GX device. The batteries will generate a total state of charge value for the whole battery bank and send this to the GX device. For more information on which brands can work with Victron and how to set them up see this link: https://www.victronenergy.com/live/battery_compatibility:start.



Other battery chemistries:

Flow batteries and other chemistries. These are commonly available in 48V. Multiple batteries can connect in parallel without any issues. Each battery has its own battery management system. Together they will generate a total state of charge value for the whole battery bank. A GX monitoring device is needed in the system. For more information on which brands can work with Victron and how to set them up see this link: https://www.victronenergy.com/live/battery_compatibility:start.

**3.3. Parallel battery bank wiring****Battery bank wiring matters**

It matters how a battery bank is wired into the system. When wiring a battery bank, it is easy to make a mistake. One of the most common mistakes is to parallel all the batteries together and then connect one side of the parallel battery bank to the electrical installation. As indicated in the image on the right.

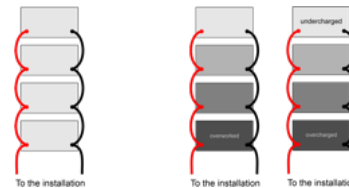
**What happens when a load is connected?**

The power flow from the bottom battery only goes through the main connection leads. In contrast, the power from the subsequent batteries has to traverse the main connection and the additional interconnecting leads to reach the next battery. As the number of batteries increases, the number of interconnecting leads also increases. This results in a decrease in the current available from the top battery compared to the bottom battery.

What happens if the battery bank is charged?

The bottom battery gets charged with a higher current than the top battery. The top battery gets charged with a lower voltage than the bottom battery. The result is that the bottom battery is worked harder, discharged harder and charged harder. The bottom battery will fail prematurely.

Why is cable resistance important when wiring battery banks?

Remember that a cable is a resistor. The longer the cable, the higher the resistance. Also, the cable lugs and the battery connections will add to this resistance.

To give an indication of this, the total resistance for a 20cm, 35m² cable together with cable lugs attached is about 1.5mΩ. You might say that 1.5mΩ is not much but remember that the internal resistance of a battery is also low. Therefore, it does matter a lot! The internal resistance of a battery is typically between 10 to 3mΩ.

If you construct an electrical diagram of an incorrectly wired battery bank it will look like this:

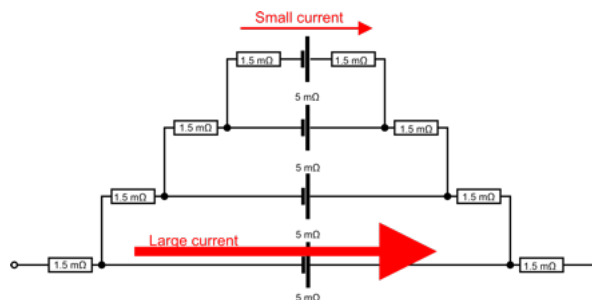

Current will always choose the path of least resistance. Most of the current will therefore travel through the bottom battery. And only a small amount of current will travel through the top battery.

The correct way of connecting multiple batteries in parallel is to ensure that the total path of the current in and out of each battery is equal.

There are four ways to correctly wire a parallel battery bank:

- Use busbars.

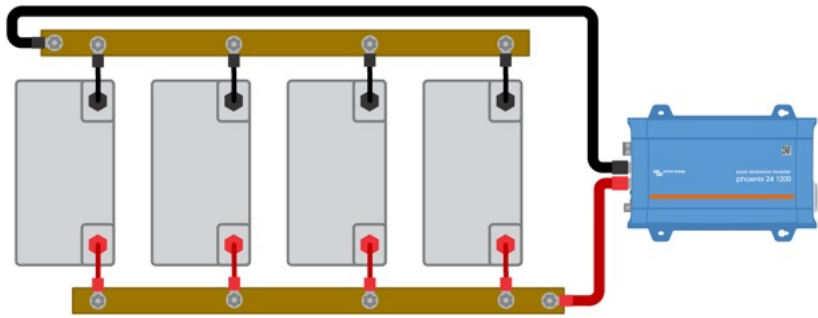

- Connect using positive and negative posts. Ensure equal cable length from each post to each battery.

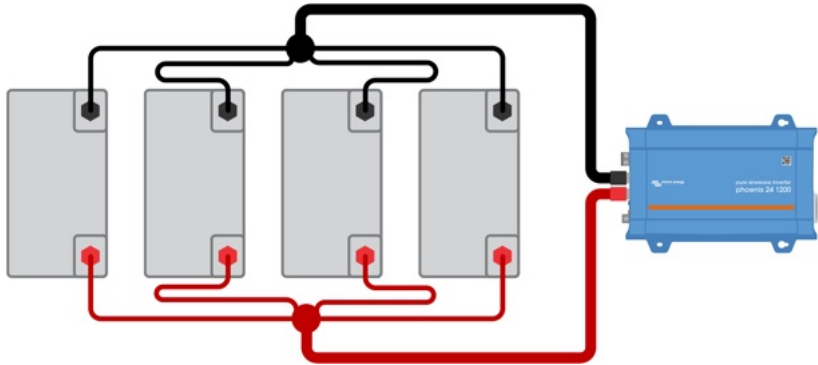

- Connect halfway. Ensure all cables have the same thickness.

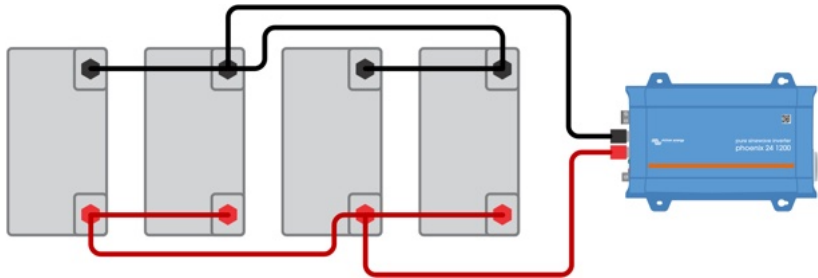

- Connect diagonally. Note that while connecting the battery this way is simple and effective, it is not perfect. There may still be slight differences in the individual battery currents.

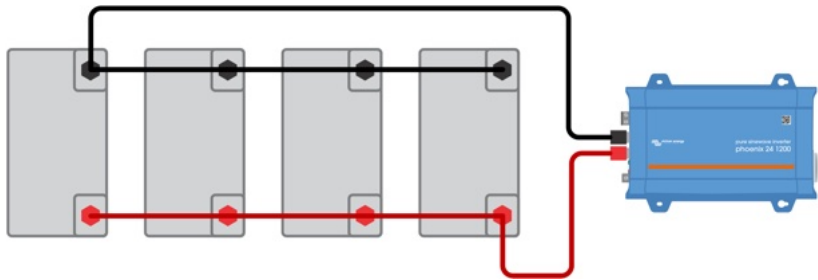

3.4. Lead-acid battery bank balancing

When creating a lead-acid battery bank with a higher voltage, like 24 or 48V you will need to connect multiple 12V batteries in series. But there is one problem with connecting batteries in series, and this is that batteries are not electrically identical. They have slight differences in internal resistance. So, when a series string of batteries is charged, this difference in resistance will cause a variance in terminal voltages on each battery. Their voltages become “unbalanced”. This “unbalance” will increase over time and will lead to one of the batteries being constantly overcharged while the other battery is constantly undercharged. This will result in a premature failure of one of the batteries in the series string.

How to check if a battery bank is balanced:

- Charge the battery bank.
- Measure towards the end of the bulk charge stage. This is when the charger is charging at full current.
- Measure the individual battery voltage of one of the batteries.
- Measure the individual battery voltage of the other battery.
- Compare the voltages.
- If there is a noticeable difference between these voltages, then the battery bank is unbalanced.

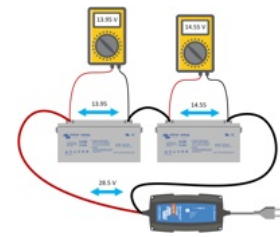

How to prevent battery unbalance on initial installation:

To prevent initial battery unbalance, make sure you fully charge each individual battery prior to connecting them in series (and/or parallel). To prevent unbalance in the future, as the batteries are aging, use a Battery Balancer. The battery balancer is wired into a system as indicated in the image on the right. It measures the battery bank voltage and also the individual battery voltages.

How the Battery Balancer works:

- The battery balancer activates as soon as the battery bank is being charged and the charge voltage has reached more than 27.3V.
- At that moment, the battery balancer will start to measure and compare the voltages of both batteries.
- As soon as it detects a voltage difference of more than 0.1V between the two batteries, it will illuminate a warning light and it will start to balance the two batteries.
- It does this by discharging the higher battery by drawing a current of up to 0.7A from that battery until both battery voltages are equal.



If battery balancing does not have the required effect and the voltage difference becomes larger than 0.2V, the battery unbalance is larger than the battery balance can correct. This is most likely an indication that one of the batteries has developed a fault and the Battery Balancer will sound an alarm and it will activate its alarm relay.

For a 24V system, a single battery balancer is needed. And for a 48V system, three battery balancers are needed, one between each battery.

For more information see the product information page of the Battery Balancer at: <https://www.victronenergy.com/batteries/battery-balancer>

3.5. Battery bank midpoint

Battery unbalance can be detected by looking at the midpoint voltage of a battery bank. If the midpoint voltage is monitored, it can be used to generate an alarm when it deviates beyond a certain value.

Both a battery balancer and a battery monitor can generate a midpoint alarm.

The BMV 702, BMV 712 and SmartShunt battery monitors all have a second voltage input that can be used for midpoint monitoring. It can be wired to the midpoint of the battery bank. The battery monitor will display the difference between the two voltages or as a percentage. For more info see the battery monitor product page at: <https://www.victronenergy.com/battery-monitors>

A midpoint alarm can mean the following:

- An individual battery has failed, like an open cell or short-circuited cell.
- An individual or multiple batteries have reached the end of their lifetime due to sulfation or shedding of active material.
- Equalization is needed (only for wet cells).



In a series/parallel battery bank it can be helpful to connect the midpoints of each parallel series string. The reason to do this is to eliminate unbalance within the battery bank.

How to connect midpoints:

<ul style="list-style-type: none"> If you connect batteries in series/parallel, like the image on the right, you will see that the individual voltages will vary per series string and they will also vary within the string. 	
<ul style="list-style-type: none"> First, make sure that each string has the same voltages by using a common negative and positive connection point or busbar. 	
<ul style="list-style-type: none"> Once each string voltage is equal, the midpoints can be connected. Make sure that the midpoint cabling is able to carry the full current between the batteries. 	
<ul style="list-style-type: none"> Once the midpoint of the battery bank is connected one battery balancer can be used, instead of using 3 battery balancers (one for each string). Also, a single BMV can be used for midpoint monitoring of the entire battery bank. 	

Do not connect loads to the midpoint of a battery:

It is not recommended to connect loads to the midpoint of a battery bank in order to be able to run loads that require a lower voltage. Doing so will create a large imbalance in a battery bank. This imbalance is much bigger than a battery balancer can potentially rectify (larger than 0.7 A) and the battery that is used to provide the lower voltage will fail prematurely.

The only reason to use the midpoints of a battery bank is for balancing and/or monitoring purposes.

Do not do this:

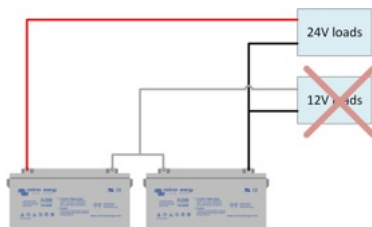

But instead use an Orion DC-DC converter:

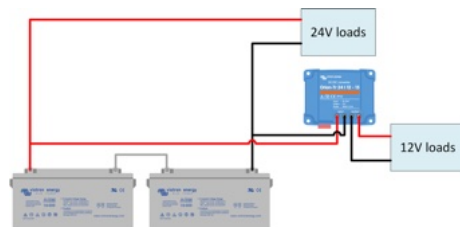

4. DC wiring

It is important to use the correct cable thickness in a system. This chapter explains why and contains other useful information on what to look out for when designing a system's DC wiring.

4.1. Cable selection

The correct cable can only be selected once you know the currents in a system. To find out how to calculate the current see the [Current, cable resistance and voltage drop \[8\]](#) chapter.

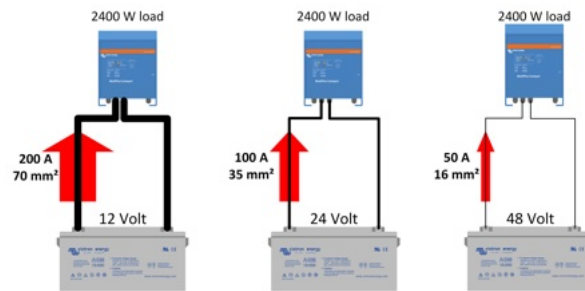

The below list shows an example of what cable size belongs to these currents, providing that the cable distance is less than 5 meters.

The preferred upper inverter power limits per system voltage are:

- **12V:** up to 3000VA.
- **24V:** up to 5000VA.
- **48V:** 5000VA and up.

In order to avoid very thick cables, the first thing you should consider is to increase the system voltage. A system with a large inverter will cause large DC currents. If the DC system voltage is increased, the DC current will drop, and the cables can be thinner.

If you want to increase the system voltage, but there are DC loads or DC charge sources that only can deal with 12V, you could consider using DC-DC converters rather than choosing a low voltage for the entire system.

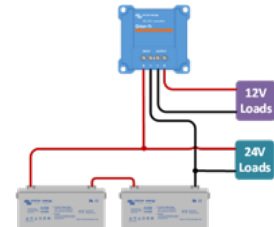

As explained already, it is very important to always use the right cable thickness. You can find the correct cable thickness in the product manual. Using a too-thin cable has a direct negative effect on system performance. Generally, cable core thickness is indicated in mm^2 . This indicates the surface area of the cable core. But other annotations are used as well, like AWG (American Wire gauge). Please see the end of this chapter for a AWG to metric conversion chart.

- To find out the core diameter of a stranded core cable, look at the cable insulation. There will be markings on the cable that indicate cable core thickness.



Be aware that some cables can have very thick insulation and they may appear thicker than they are. Find out the actual core diameter by looking at the cable marking or at its specifications, or alternatively do a physical check. Strip a bit of cable insulation away and look at the copper core of the cable and estimate the core diameter. In a solid cable, you can calculate the surface area if you measure the diameter of the cable core, but in a stranded cable this method is not that precise. (Please note that we do not recommend using solid core cables).



If you cannot find a thick enough cable, double up. Use two cables per connection, rather than one very thick one. But if you do, always make sure that the combined surface area of both cables is equal to the recommended surface area. For example, 2 x 35mm² cables equal one 70mm² cable. Larger Victron inverter/chargers are equipped with two positive and two negative battery connections, especially for this purpose.

When selecting cables avoid these mistakes:

- Don't use cables with coarse strands.
- Don't use non-flexible cables.
- Don't use AC cables.
- For marine or moist situations use "marine cables". These are cables with tin-coated copper strands.



From left to right: non-flexible cable, cable with coarse strands, correct cable with fine strands, correct marine cable with tin coated strands.

Calculating cable thickness can be difficult. There are ways to help you with selecting the correct cable thickness:

- Look in the product manual.
- The Victron toolkit app.
- The rule of thumb.
- Recommended battery cables table.

Product manuals:

All our manuals recommend the DC battery cable size (and fuse size) that needs to be used for the product.

The Victron toolkit app:

The Victron app helps you calculate cable size and voltage drop. The app is free of charge and can be downloaded here: <https://www.victronenergy.com/support-and-downloads/software#victron-toolkit-app>

You can enter the following parameters:

- Voltage.
- Cable length.
- Current.
- Cable cross-section.

Once the parameters have been entered, the app will calculate the voltage drop over both cables. You should aim for a voltage drop below 2.5%.



Recommended battery cables table:

The table below shows the maximum current for a number of standard cables where the voltage drop is 0.259 Volt. This table uses the total cable length, this is the length of the positive cable plus the length of the negative cable. Not that the losses over the contacts are not included.

Cable diameter (mm)	Cable cross-section (mm ²)	Maximum current (A) for a total cable length up to 5 meters	Maximum current (A) for a total cable length up to 10 meters	Maximum current (A) for a total cable length up to 15 meters	Maximum current (A) for a total cable length up to 20 meters
0.98	0.75	2.3	1.1	0.8	0.6
1.38	1.5	4.5	2.3	1.5	1.1
1.78	2.5	7.5	3.8	2.5	1.9
2.26	4	12	6	4	3
2.76	6	18	9	6	5
3.57	10	30	15	10	8
4.51	16	48	24	16	12
5.64	25	75	38	25	19
6.68	35	105	53	35	26
7.98	50	150	75	50	38
9.44	70	210	105	70	53
11.00	95	285	143	95	71
12.36	120	360	180	120	90

Rule of thumb:

For a quick and general calculation for cables up to 5 meters use this formula:

$$\text{Current} / 3 = \text{cable size in mm}^2$$

For example: if the current is 200A, then the cable needs to be: $200/3 = 66\text{mm}^2$

AWG to Metric conversion chart

This table shows the conversions and resistance for cables up to AWG 10. For the full table (up to AWG 40), see this link: <https://www.victronenergy.com/upload/documents/AWG%20to%20Metric%20Conversion%20Chart.pdf>

AWG	Diameter (in)	Diameter (mm)	Surface area (mm ²)	Resistance (ohm/m)
4/0 = 0000	0.460	11.7	107	0.000161
3/0 = 000	0.410	10.4	85.0	0.000203
2/0 = 00	0.365	9.26	67.4	0.000256
1/0 = 0	0.325	8.25	53.5	0.000323
1	0.289	7.35	42.4	0.000407
2	0.258	6.54	33.6	0.000513
3	0.229	5.83	26.7	0.000647
4	0.204	5.19	21.1	0.000815
5	0.182	4.62	16.8	0.00103
6	0.162	4.11	13.3	0.00130
7	0.144	3.66	10.5	0.00163
8	0.128	3.26	8.36	0.00206
9	0.114	2.91	6.63	0.00260
10	0.102	2.59	5.26	0.00328

4.2. Busbars

Busbars are like cables, only they are rigid metal bars. They are made of copper or tinned copper. They are used in large systems where large currents flow. They provide a common positive and a common negative point between the batteries and multiple inverters. Busbars are also used in smaller systems, especially when there is a lot of DC equipment. A busbar in this case provides a nice location to connect all the various DC cables to.

To calculate busbar thickness, simply use the recommended cable surface area and apply that to the busbar cross-section area.

$$\text{surface area} = \text{width} \times \text{depth}$$

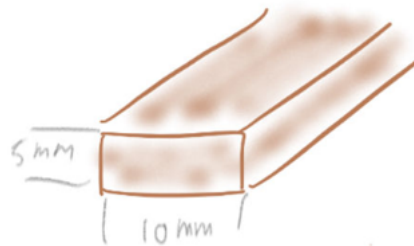

For example:

- A busbar of 10mm x 5mm.
- The surface area cross-section is $5 \times 10 = 50\text{mm}^2$.
- This should be suitable for 150A for distances up to 5 meters.

When wiring the system, please make sure that the cross-section of the connection between the batteries and the DC distribution point equals the sum of the required cross-sections of the connections between the distribution point and the DC equipment. See the below image for examples of this.

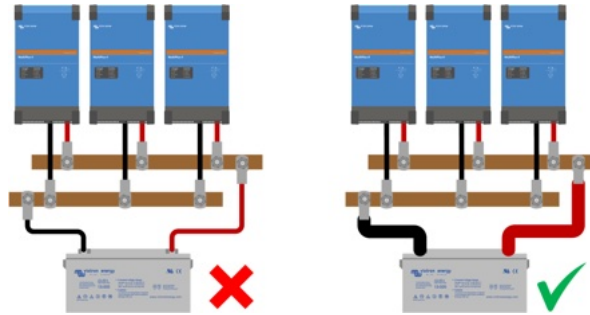

 **CAUTION:** Busbars are not insulated. To prevent short circuits or electric shock use insulated tools and do not wear metallic jewellery,



When using busbars, it is in most cases necessary to shield the busbar, especially if the busbar is out in the open. This is to prevent people from touching the busbar, or to prevent a short circuit if a metal object should accidentally fall across the positive and negative busbars and short circuit both busbars. An easy way to do this is to mount a Perspex sheet in front or over the busbar. See the image on the right.



Busbars can be easily made by yourself, you simply need a copper or brass bar in which you drill holes so that electrical cables can be connected to the bar. For marine applications use tinned copper or brass. Busbars can be purchased from electrical wholesalers or metal suppliers.



Victron has a number of products that contain busbars. These can also be found on our DC distribution systems and fuses product page. For the full product information follow this link: <https://www.victronenergy.com/dc-distribution-systems>.

Victron busbar overview:	
Busbars that are rated at 150, 250 and 600A, with a variety of connection options and with and without covers (the 250A 6p model is pictured on the left).	
Fuse holder 6-way for MEGA fuses with a 250A busbar.	
Modular MEGA fuse holders: <ul style="list-style-type: none"> • 5 position busbar, 500A rating. • 6 position busbar. 1500A (pictured on the left). 	

The Lynx distribution system consists of separate modules that can be connected to each other to form a continuous busbar for 12, 24 or 48V systems:

- a. Lynx Smart BMS - A BMS for our Smart lithium batteries, with a battery monitor and Bluetooth. Uses VE.Can communication to read out Lynx distributor fuse information and to communicate with a GX device. Rated at 500A.
- b. Lynx distributor - to connect up to four DC loads or batteries and their fuses and indication light per fuse. (multiples can be connected). Rated at 1000A.
- c. Lynx shunt - A battery monitor and main fuse holder. Uses VE.Can communication with a GX device and to read out the battery monitor. Rated at 1000A.
- d. Lynx Power in - to connect batteries (a Lynx distributor can also be used). Rated at 1000A.

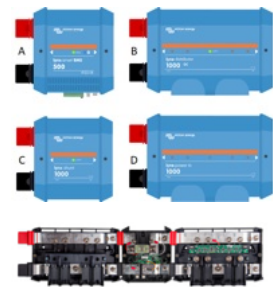

4.3. Cable connections

There are several ways to connect cables to batteries or to Victron products and connections are made in a variety of ways.

Bolts, nuts and screws

These usually come in sizes like M5, M6, M8 or M10. Note that bolts used for electrical purposes are usually made out of tinned brass. So, when tightening these always use the correct torque. Over-tightening might break the nut or bolt. See the product manual for the recommended torque.

Cable eye lugs are used to connect the cable to a bolt. The cable lug needs to match the cable thickness. A special crimping tool is needed to attach a cable lug onto a cable. If the cable lug does not have insulation you will need to add this.

When connecting the cable eye to the bolt, place a washer and spring ring and then the nut. Ensure that the lug is flat against the surface below. Do not insert anything between the lug and the mounting surface, like washers or fuses. This will reduce the current carrying capacity of the connection.

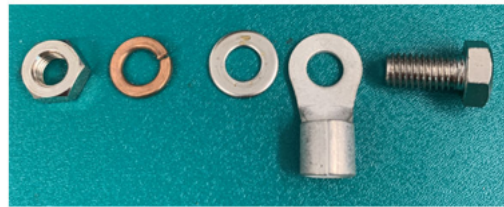
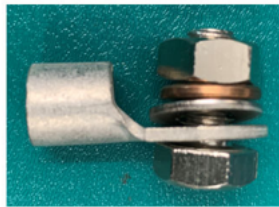

Use insulated tools when tightening the nut. An accidental battery short circuit can be very dangerous, and the currents can melt your uninsulated spanner, or the spark can cause a battery explosion.

Screw connectors

Screw connectors come in a variety of shapes and sizes, suitable for thick or thin wires. For an indication of the maximum wire size that can be used in a screw connector, refer to the product manual.



Strip a sufficient length of cable insulation before inserting the bare end into the connector cavity. Avoid cable insulation entering the connector. This can lead to too much resistance. The connector will heat up and potentially melt. Avoid bare cable that is visible outside the connector. This is dangerous it can cause electrocution or a short circuit.

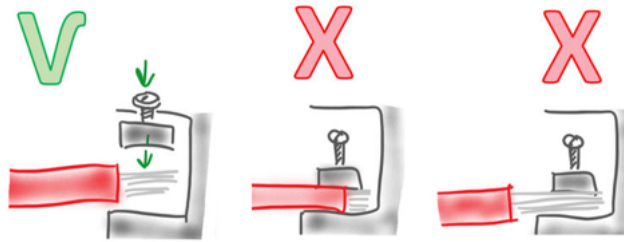

The screws inside electrical connectors are usually made out of tinned brass. When tightening always use the correct torque. Over-tightening might break the screw. See the product manual for the correct torque.

Also, never use rigid cable starts or solder the cable strands together, this will create poor contact inside the screw connector, the wire might come loose, or this creates too much contact resistance. Too much resistance will cause the connector to heat up.

It is highly recommended to use ferrules (also see next section). Ferrules will align the cable strands and keep them together. This will create the optimal contact inside the screw connector.

Ferrules

These are sleeves that slide over a stripped cable end and are attached to the cable using a special crimping tool.

They are used to align the stripped cable strands and to prevent them from splaying when inserting a cable into a screw or push connector.



What happens if no ferrules are used?

Use ferrules for all wiring connections, especially when connecting to a screw connector that does not have a cage. If a stranded cable is used without a ferrule the connector screw can pinch on only a few strands, and the turning motion of the screw can even twist and break the strands.

The photo on the right illustrates this. The strands of the top wire have been damaged, and only partial contact was made. The strands of the bottom cable were protected, and full contact was made.



Push connectors

This is how to use them:

- Strip away a sufficient length of cable insulation.
- Push down the orange part with a flat screwdriver.
- Insert the stripped wire.
- Avoid cable insulation entering the connector. This can lead to too much resistance and the connector will heat up and potentially melt.
- Avoid uninsulated cable (bare cable) to be visible outside the connector. This is dangerous it can cause electrocution or a short circuit.
- Release the orange part.
- The cable is now locked in place. Give the cable a small tug to check if the cable is securely fastened.



Spade terminals

A spade crimp terminal needs to be crimped to the cable with a special crimping tool. The range of these connectors includes ones with and without insulation and some with special features, like piggy back connectors.



MC connectors

These connectors are exclusively used to connect solar panels to other solar panels and/or to solar chargers. The most common is the MC4, but MC1, MC2 and MC3 also exist but are not used anymore. The letters "MC" stand for MultiContact, this is the name of one of the original manufacturers which caught on. The digits 1 to 4 stand for the contact pin cross-section in mm². Some specifics:

- They are waterproof (IP67) and can be used outdoors.
- Male or female connectors.
- Rated for 20 A, 600 V (newer versions 1500 V).
- A special crimping tool is needed.
- Can be bought as pre-assembled cables.
- MC4 Y-pieces (or Y cables) used to connect solar panels in parallel.



For more information see the [Solar \[40\]](#) chapter.

RADLOK™ connectors

Push-type DC connectors by Amphenol. These have a unique, positive locking mechanism that secures the connector in place and prevents accidental disconnection. The connector is designed to be highly reliable, with a high-level of resistance to environmental conditions, such as vibration, temperature, humidity, and exposure to corrosive agents.

Available in models ranging from 70 - 400A models rated up to 1000V. These are often used with managed batteries. For a datasheet see: <http://www.amphenol-industrial.com/images/datasheets/IDS-67%20RADLOK.pdf>.



Anderson plugs

Spring-loaded connectors made of tin- or nickel-plated copper to resist corrosion. They come in a variety of sizes to accommodate different wire gauges and current requirements. They are often used in automotive or mobile applications where rapid connection and disconnections are common.

Make sure the current rating matches the current when your system is under full load. Be aware that they will add to the cable resistance if they are located between the battery and the inverter. In this case, limit or avoid their use.



Car plugs

These are generally used in low-end automotive applications. They are not capable of carrying currents beyond 10A. As such they are unsuitable to connect an inverter. Also, consider that the circuit in the car might only have an even lower fuse rating than 10A.

When using these, take care to insert the plug correctly and deep enough. If not inserted correctly the connector can heat up and melt. Limit or avoid their use.



Battery clamps

These are only meant for temporary connections. They often do not have a high enough current rating and should never be permanently used in an electrical system. Limit or avoid their use.





4.4. Crimp terminals











Some special notes on insulated crimp terminals. These types of crimp terminals are readily available and are easy to use. They come in 3 colours, namely red, blue and yellow. These colours indicate the wire size that can be used with the crimp terminal:

- Red - for wire between 0.5 and 1.5mm².
- Blue - for wires between 1.5 and 2.5 mm².
- Yellow - for wires between 2.5 and 6 mm².

The below table indicates the maximum current per crimp terminal colour when different cable lengths are used.

	Colour	wire size mm ²	wire size AWG	5 m cable max A	10 m cable max A	15 m cable max A	20 m cable max A
	Red	0.5 - 1.5	22-16	4.5	2.3	1.5	1.1
	Blue	1.5 - 2.5	16-14	7.5	3.8	2.5	1.9
	Yellow	2.5 - 6	10-12	18	9	6	5

The crimp terminals are available in a variety of different shapes as indicated in the below table.

Spade female	Spade female Insulated	Spade male	Fork	Bullet female	Bullet male	Pin	Butt splice	Eye	Blade
									

From left to right:

- Female spade terminal, uninsulated.
- Female spade terminal, insulated.
- Male spade terminal.
- Fork terminal.
- Female bullet terminal - we do not recommend using this terminal; these often make bad contact and can be a source of system issues.
- Male bullet terminal - we do not recommend using this terminal; these often make bad contact and can be a source of system issues.
- Pin terminal.
- Butt splice terminal - we do not recommend using this terminal; these often make bad contact and can be a source of system problems. A better alternative is the WAGO Compact Splicing Connector 221-482, rated for cables up to 4mm² for more information see this link: <https://www.wago.com/global/installation-terminal-blocks-and-connectors/compact-splicing-connector/p/221-482>
- Blade terminal.

Use a professional ratcheting crimping tool to properly crimp a terminal onto the cable. The ratcheting action ensures that the correct pressure is applied to the crimp. The tool has 3 crimping areas, which are indicated with red, blue and yellow dots. These dots correspond with the crimp terminal colour. See the below image for an example of a professional crimping tool.

Also, before crimping, ensure the wire insulation is not pushed too deep into the crimp terminal. The crimp terminal has two different crimp sections, one for the wire core and one for the wire insulation. The professional crimping tool will crimp both sections at different pressure.

After crimping, it is good practice to test the crimp by giving the wire a small tug, this is to ensure that the terminal is securely crimped.



4.5. Cable runs

When running and connecting cables between all the components in a system, there are a number of practical things to watch out for in regard to these cable runs. Although you would have followed the correct cable advice, there are still some cable-related factors at play that can cause a problem in a system.

Use the correct cable thickness and if need be, double up:

The [Theory \[2\]](#) chapter of this book has explained why cables need to be a certain thickness and what are the negative effects if the cables are too thin. However, when wiring a system the required cable thickness might be not available or hard to obtain. Also, very thick cables are hard to manoeuvre or unable to make tight bends. In those cases, it is okay to use two cables instead of a single cable. A lot of inverters and inverterchargers have double positive and double negative terminals for that exact purpose.

When double cables are used it could be that each cable needs to be individually fused. The requirements can vary per country and per application, so please check your local regulations in regard to this.

Then another local requirement can be that each individual conductor must be able to carry the full load, so in this case, doubling up cables is not possible, so please check the local regulations if this applies to you.

Keep cables as short as possible:

Try to keep the distance between high current cables, like battery and inverter or invertercharger as close as possible. But do watch out, not to locate electronic equipment directly above lead acid batteries, even if the lead acid batteries are sealed.

This is so you do not need to use very thick cables. The closer the batteries, the shorter the cable and the thinner the cable can be.

Be aware that cables generate heat:

Due to the cable resistance, the cables generate heat when current is passing through them. The higher the voltage drop over the cable, the more heat is generated. For example, if the voltage drop is 2.5%, this means that if 1000W of power travels through the cable, 2.5% of that power will be dissipated as heat. So for a 1000W load, this means 25W of heat.

It is important that this generated heat can dissipate.

If cables are enclosed, for example by cable conduit, the heat might not be able to dissipate and eventually the cables heat up too much. The only solution, in this case, is to increase the cable thickness and perhaps even double it.

Use a cable conduit that is open at the top. Alternatively use thicker cables, so that the voltage drop is less and therefore less heat is generated. See the [Current, cable resistance and voltage drop \[8\]](#) chapter and the [The negative effects of cable voltage drop \[11\]](#) chapter for more information on this.

A suggestion might be to run a system at full load and check the cables with a thermal camera. This is also a good way to detect loose cable connections or badly crimped terminals.

Keep slack in the cables

Tight cables together with vehicle vibration is not a good thing. The crimp terminals and battery poles are under too much stress and will come loose over time. A good example of this is the wiring between batteries to form a large battery bank. If the interconnecting wires do not have some slack and the batteries might not be totally immovable there will be too much strain on the battery terminals or the cable terminals and eventually, they will become loose or damaged.

Use strain reliefs

thick cables are heavy, do not let the full weight of a thick cable fully hang off an inverter, inverter/charger or battery connection. This is especially important if the installation is exposed to vibration. Strain reliefs or cable mounting brackets will take the weight of the cable.

4.6. Fuses and circuit breakers

A fuse is an electrical safety device. It protects an electrical circuit against high currents.

The fuse is placed in the supply cable to an electrical device. As soon as current flows through the fuse that is higher than its current rating, for a certain amount of time, the fuse will blow. Once the fuse has blown, no more current will flow into the circuit. Higher-than-expected current situations could occur when an electrical device develops a fault or when there is a short circuit in the electrical circuit.

The fuse protects wires and equipment against:

- Overcurrent - when more current runs in the system than it is rated for.
- Short circuit - when one conductor accidentally comes in contact with another conductor.

How does a fuse work?

There are three types of fuse mechanisms, being:

- Wire fuse (one time only).
- Thermal fuse (resettable).
- Magnetic fuse (resettable).

The "one time only" fuse:

Traditionally, a fuse contains a wire or a strip of metal that melts as soon as an unacceptable high current passes through the fuse. When the wire in the fuse has melted, the electrical circuit has been broken and no more current will flow in the circuit. Once the fuse has blown" it will need to be replaced by a new fuse to make the circuit operational again. These fuses are one-time use fuses. Once they have blown, they can't be reset. They need to be replaced by a new one.

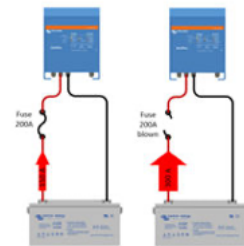

The re-settable (or automatic) fuse:

Another type of fuse is the automatic fuse, often called circuit breaker or miniature circuit breaker (CB or MCB). These devices interrupt the current flow when high current is detected. Sometimes they will reconnect after the high current event has passed, or they need to be manually reset. They do not need to be replaced like the traditional fuses.

There are 2 ways how these fuses operate, either thermal or magnetic or a combination of these :

- The thermal circuit breaker contains a bi-metal strip that heats up when over current flows. It bends when heated up and by doing so, it will break the current path.
- The magnetic breaker contains an electromagnet that is sensitive to a large current. When a large current flow the electromagnet creates a magnetic force that breaks the path of the current.

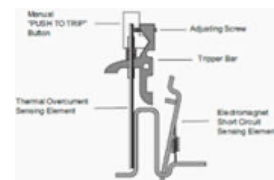

Location of the DC fuses:

Each consumer that connects to a battery needs to be fused. The fuse is placed in the positive cable. Each individual consumer needs to have an individual fuse. No matter how big or small the power rating of the equipment is. Batteries can potentially produce very high currents that can cause a fire. If the consumer develops a fault and internally short circuits, a very large current will flow, potentially causing a fire hazard. A DC circuit usually contains a main battery fuse, after which it branches off to the individual consumers. Each consumer has an individual fuse.

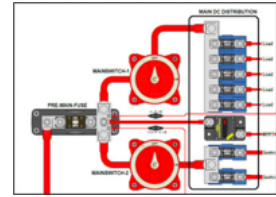
**Location of the AC circuit breakers:**

The circuit breakers are located near the entry point of the public grid and/or the generator into the switchboard. The AC breaker is placed in the live conductor or in both the live and the neutral conductor. Single or double pole circuit breakers are used. There usually is one main circuit breaker per AC supply, after which the supply branches off into a variety of groups. Each group contains a circuit breaker, protecting a group of AC consumers.

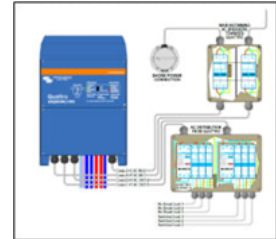
**Location of the PV array circuit breakers:**

A fuse needs to be located between a PV array and the solar charger. Please check with the local authorities, regulations per application and country will vary.

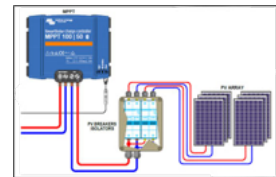
**Fuse holders**

Fuses need to be placed in fuse holders. The fuse holder securely holds the fuse in place. And in some cases, they also provide electric insulation. Circuit breakers are usually mounted on DIN rail. Fuses and circuit breakers are usually located in a switch board, preferably inside an enclosure.

Fuse ratings and how to select the correct fuse:

When selecting a fuse there are 4 selection criteria: ·

- Current rating
- Voltage rating
- Speed
- Type

It is important to choose the correct fuse that will match the circuit and match the power consumption of the equipment in that circuit. The rating of the fuse is displayed on the fuse or can be found in the fuse's datasheet or its specifications.

Current rating

If there is only one consumer in a circuit, the fuse will need to match the current rating of that consumer or the current rating of the cable, whichever is the lowest of the two. If there are multiple consumers in a circuit, then the fuse will need to match the current rating of the cabling in the circuit.

Voltage rating

The fuse voltage rating needs to be equal to or bigger than the expected maximum voltage in the system. The fuse needs to be specifically rated for the required type, DC and/or AC. Most DC fuses are suitable for 12 and 24 V, but they are not necessarily suitable for 48 V and higher. Please note that not all fuses or circuit breakers can be used in both AC and DC circuits. If the fuse is able to be used for both AC and DC, the voltage for AC is often rated higher than the DC voltage rating. Also, take care that circuit breakers might not be unidirectional, so for DC, it matters which way they are wired into the circuit.

Speed

The speed of a fuse is the time it takes for the fuse to open when a fault current occurs. This is dictated by the fuse material, its mechanism, the current and the temperature.

There are slow and fast blow fuses:

- Slow blow fuses are commonly used in DC applications that can be found in automotive and marine circuits. These circuits contain consumers with a high start-up current, like motors, or devices with capacitors, like an inverter. The slow blow fuse will withstand a high, short duration, initial current, enabling a motor to start.
- Fast blow fuses are used in AC applications. AC consumers are often sensitive to changes in the flow of electricity, so they need a fuse that can react fast, to protect the consumer. But in some cases, an AC consumer can have a high start-up current, this is equipment with electromotors, such as refrigerators, air-conditioners and compressors. In these scenarios, a slower fuse will be needed.

Fuse element speed range:

- FF Very Fast Acting (Flink Flink).
- F Fast Acting (Flink).
- M Medium Acting (Mitteltrage).
- T Slow Acting (Trage).
- TT Very Slow Acting (Trage Trage).

Fuse markings



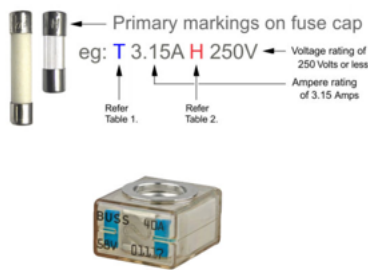









The fuse contains marking as to what its ratings are. But information might be missing. Then a good source to find out more are the fuse specifications. These can be easily found online or from your fuse supplier.



Catalog Number	Marine Rated Battery Fuses
Application	Full range circuit protection for automotive and marine applications. Break in capacity meets the requirements of conventional vehicle batteries and 42V electrical networks
Voltage Rating	58Vdc: Maximum
Amperage Rating	30A - 300A
Ingress Protection	IP66
Ignition Protected	Per SAEJ1117
Interrupt Rating	10000 AMP @ 14Vdc; 5000 AMP @ 32Vdc; 2000 AMP @ 58Vdc
Torque Rating	Maximum 12 Nm (106 in-lbs)
Material	Body - Ceramic Housing & Cover; UL-rated 94V0 Thermoplastic Ring Terminals - Tin Plated

Overview of fuse types:

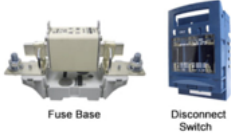
Fuse type	Fuse	Fuse holder
Glass or ceramic fuses <ul style="list-style-type: none"> • Wire fuse • Up to approximately 60A • Up to 250V AC or DC • Fast or slow 		
Blade fuses (automotive) <ul style="list-style-type: none"> • Wire fuse • Up to 120A • 32V DC • Slow 		

Fuse type	Fuse	Fuse holder
<p>Midi Fuses</p> <ul style="list-style-type: none"> • Wire fuse • 23 – 200A • 32 Vdc • Slow 		
<p>Cooper Bussmann MRBF fuses</p> <ul style="list-style-type: none"> • Wire fuse • 30 – 300A • 58 Vdc • Marine rated • For tight space constraints. Can be mounted straight on a DC terminal, such as on a busbar. It also reduces the total amount of cable and crimp terminals needed. 		
<p>CNN fuses</p> <ul style="list-style-type: none"> • Wire fuse • 10 – 800 A • 48 Vdc, 125 Vac • Fast 		
<p>Mega fuses</p> <ul style="list-style-type: none"> • Wire fuse • 40 - 500A • 32 Vdc • Slow 		
<p>ANL fuses</p> <ul style="list-style-type: none"> • Wire fuse • 35 – 750 A • 32V dc • Fast 		
<p>NH fuses</p> <ul style="list-style-type: none"> • Wire fuse • Up to 1000A • 500 - 690 Vac 440 - 550 Vdc • Multiple speeds available 		
<p>Circuit breakers (CB or MCB)</p> <ul style="list-style-type: none"> • Thermal and magnetic • A variety of current ratings • A variety of voltages • AC or DC • A variety of speeds • Mounts on DIN rail 		

4.7. DC isolation switches

A battery isolation switch can be used to isolate the battery (or battery bank) from the rest of the electrical circuit. Or it can be used to isolate a DC source or DC consumer from an electrical circuit.

Being able to isolate a battery or DC consumer from the electric circuit is useful in case the system is not going to be used for a certain amount of time or for system maintenance. When selecting an isolator switch always make sure that the isolator switch is rated to the currents that can be expected in the system under full load.

The rules and guidelines for battery isolation vary in different countries, but it is recommended that if battery isolation is needed, to only isolate the positive battery cable.

It might not even be necessary to add an isolator switch. A DC system should always contain a main fuse. Removing the fuse will also break the circuit. So, when the system needs to be maintained or if the battery needs to be replaced, removing the main fuse will be sufficient to isolate the battery from the rest of the system.

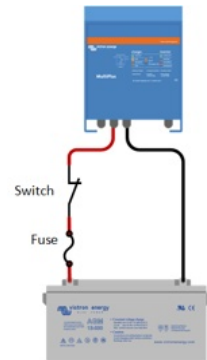

Always use quality isolator switches. The isolator switch will add to the circuit resistance. A low-quality switch will have more resistance, this can potentially increase the voltage drop and will cause system issues.

Isolator switches are rated for a certain voltage and a continuous current (make sure it is DC current) and are often also rated for a 5-minute current and a few seconds peak current.

Some isolator switches are not designed to break current (especially DC current) and some battery switches cannot switch under load. Please refer to the isolator switch technical specifications.

Types of isolator switches:

- Battery isolator switch for mobile systems (usually 12 and 24 V). Note that the Victron Energy [Battery Switch ON/OFF 275A](#) is able to switch 12, 24 and 48V and is also able to switch under load.
- DIN mounted circuit breakers, for land-based systems for battery and PV (usually 48 V and up).
- NH fuse holder switch for high current land-based systems for battery and PV (usually 48 V and up).



Victron Energy Battery Switch ON/OFF 275A.

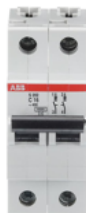

High current DC MCB.

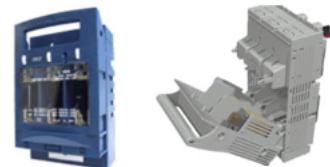

NH fuse holders can be used as a circuit breaker.

Systems with multiple inverters or inverter/chargers

Each unit needs to be fused individually. Make sure that the same type of fuse is used for each individual unit. This is to ensure each DC path has the same resistance.

Do not have one big circuit breaker or fuse that switches the entire system. The reason why is that a short circuit (or another failure) in a single inverter/charger will (almost) never have a resistance low enough to make the large single fuse blow or trip. If that fuse does not blow, the current will continue to flow at a level that is too high for the internal or external inverter/charger wiring.

It is preferred (not mandatory) that there is a continuous negative DC connection in the system, and that only the positive DC connection of each inverter/charger is switched, protected or fused. The reason why is that it can be very tricky to troubleshoot a system if there is a loose connection in the DC negative path, especially in systems consisting of multiple units (parallel-, split-, three-phase). Note that a continuous negative connection is not a requirement as certain installations might require that the DC negative is protected with a fuse or circuit breaker.

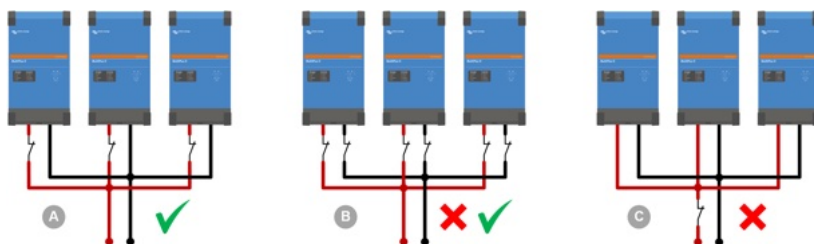

- Each unit's positive DC supply is switched individually.
- Each unit's positive and negative DC supply is switched individually.
- The main supply to all units switched as a whole. Note that this is not recommended!

4.8. Shunt

A shunt is added to a system to measure current flow. This is needed for system monitoring or to calculate the battery state of charge.

A shunt is a resistive element. When current passes through it a small voltage drop will occur over the shunt. If the current is small the voltage will be low, and if the current is large the voltage will be higher. If the current flow reverses, the voltage drop will change polarity. The voltage of the shunt is an indication of the amount of current and the direction of the current. This information can be used to find out how much current runs into a system or for the battery state of charger calculation.

A shunt has a current and a voltage rating, for example, 500A, 50mV. This means that if a 500A current passes through the shunt, there will be a 50 mV (= 0.05 V) voltage drop over the shunt.

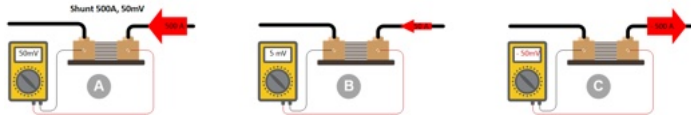

- A. A large current passes through a shunt.
- B. Less current passes through a shunt.
- C. Reverse current passing through a shunt.

The shunt needs to be rated to the maximum DC current that will flow into the combined consumers in the system.

Example: An inverter is connected to a battery. The maximum current will be the peak rating of the inverter. A 3000VA inverter has a peak current of 6000W, this is, at 12V a 500A current.



- A. 500A BMV shunt.
- B. 2000A SmartShunt.
- C. 6000A shunt.

The Victron SmartShunt is available with a 500A, 1000A or 2000A 50mV shunt. The Victron BMV battery monitor ships with a 500A, 50mV shunt. In case this shunt is not big enough you will need to add a bigger shunt. Victron 50mV shunts are available in 500, 1000, 2000 and 6000A. When using a shunt with a different voltage or current rating, make sure that you change the shunt parameters in the BMV battery monitor settings.

The shunt is typically located in the negative cable. The negative is chosen because that is safer. The shunt needs to be the last item before the battery bank or battery bank busbar. All DC consumers and DC supplies need to be connected after the shunt. See on the right how to wire the shunt into a system. Shunts can also be placed elsewhere in a system, for example: to measure a DC consumer or a DC supply. These shunts usually connect to a current meter.



Please be aware that misplacement of the shunt can potentially cause a problem in a system depending on how it is wired in. This is especially the case in very large systems where there is a long path between the battery and the inverter/chargers. When inverting, the inverter/charger near the shunt will “see” a lower DC input voltage than the units far away from the shunt. When charging, the batteries near the shunt will “see” a lower DC input voltage than when the batteries are further away from the shunt. See the below images. To fix this, move the shunt away from the positive cable (not ideal). Or consider not using a shunt at all but use smart batteries that generate their own state of charge instead.

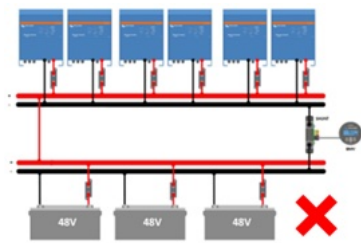

The shunt is incorrectly placed.

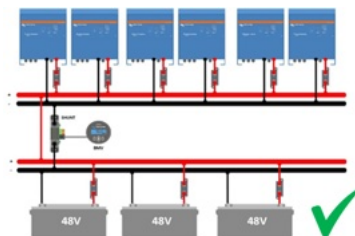

The shunt is correctly placed.

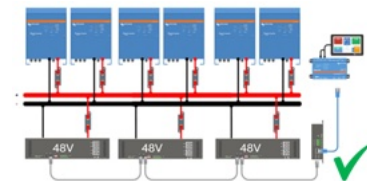

Smart batteries are used and no shunt is needed

4.9. Parallel and/or 3-phase system DC wiring

A large inverter/charger or a 3-phase inverter/charger can be created by connecting multiple inverter/chargers together. These units communicate with each other and, together, they become one large inverter/charger. They all need to be connected to the same battery bank. When wiring an installation like this, there are some important considerations regarding the battery cables.

For correct operation, it is essential that each unit receives exactly the same voltages. To ensure this, the DC path from the battery bank to each individual unit, or from the busbar to each individual unit needs to be exactly the same.

If there is a difference between the cable thickness or the cable length between the individual units, there will be a difference between the voltages of these units.

Different voltages mean different currents. The unit with a lower voltage will have a higher current running through its power electronics. Inverter/charger overload is triggered by the amount of this current. So, although the power that each inverter delivers will be the same, the unit with the lower voltage will have a larger current running through it and will go into overload before the other units do. The total inverter power of the system will now be less because when one unit goes into overload, the whole system will stop working. The unit with bad wiring will determine the performance of the whole system.

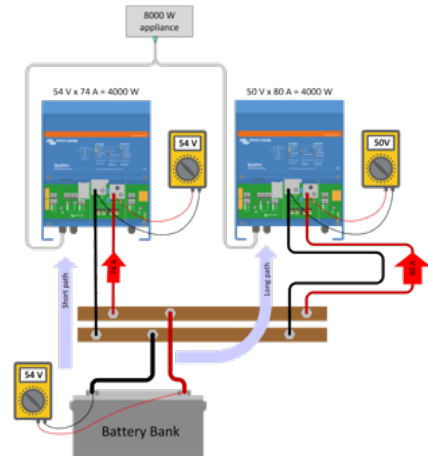

To achieve a balanced system, you will need to use the same cable type, cross-section and cable length for each unit from the battery bank or from the busbars. Also, ensure that all cable lugs are identical, and all connections are tightened with the same torque values. Consider using busbar power posts between the battery bank and the inverter/chargers.

When placing fuses into the installation consider using only one DC fuse per phase. If a big single fuse is not available, then use one fuse per unit, but make sure that all these fuses are exactly the same.

To check if a system is correctly wired or to troubleshoot wiring follow these steps:

- Load the system to maximum load.
- Current clamp the DC wires to each unit.
- Compare the current readings, each unit should have similar DC currents.

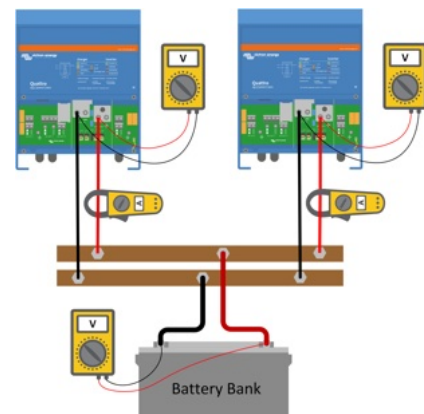

Alternatively, you can measure the voltage on the busbar or battery bank and compare this with the voltages you measure at each unit's battery terminals. All these voltage readings should be identical.

For more info on parallel and 3 phase systems see this link: https://www.victronenergy.com/live/ve.bus:manual_parallel_and_three_phase_systems.

4.10. Large system busbars

Large installations typically consist of multiple DC consumers and DC sources. Like multiple batteries, multiple inverter/chargers and multiple solar chargers. They all connect to a central busbar. When wiring these installations, special considerations need to be made.

In these systems, you will need to use busbars, but even still, it matters how all equipment is connected to the busbar and in what order. It is important to alternately connect the inverter/chargers and the solar chargers to the busbars. The reason is that this will reduce the current flowing through the busbars. To simply put it, the current entering the busbar from a solar charger can travel via a short path straight into the inverter or into a battery. This current does not need to travel through the entire busbar. It keeps the local "traffic" low.

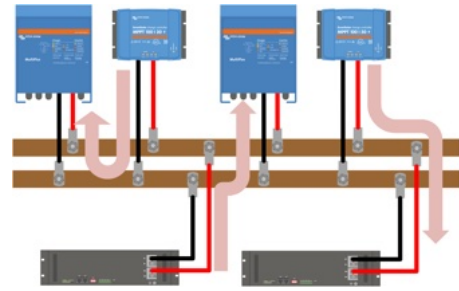

Current flow via the busbar.

When wiring, make sure all inverter/chargers have the same cable length. Also, the solar chargers need to have approximately the same cable length. And the same for the batteries.

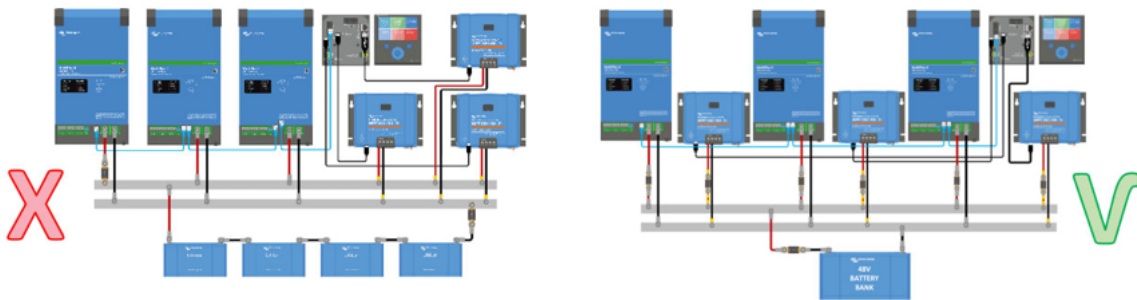

Do not have all inverter/chargers on one side and the solar chargers on the other side.

Intermix the inverter/chargers and the solar chargers.

If the system has only one battery bank you should connect the battery bank in the middle of the busbars. But in the case of several parallel battery banks or smart batteries, they should also be distributed evenly along the busbars.

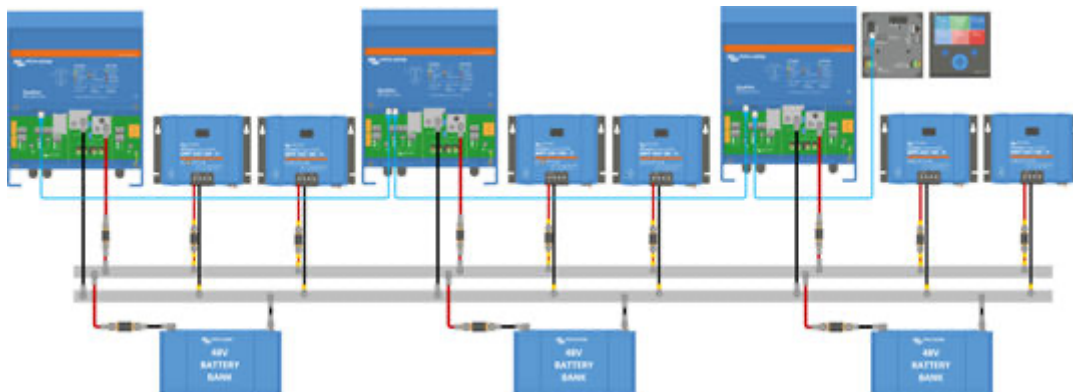

If the system has individual batteries, also intermix these with the inverter/chargers and the solar chargers.

4.11. Voltage sensing and compensation

Voltage sensing is a battery charger feature. It works by measuring the difference between the voltage in the unit and the voltage at the battery terminals. As soon as a difference is detected, the charge voltage will be increased to compensate for cable losses during charging. This will ensure that the batteries are always charged with the correct voltage. This feature generally will only compensate for voltage losses up to 1V. If the losses in the system are bigger than 1V (i.e. 1V over the positive connection and 1V over the negative connection), the battery charger, solar charger or inverter/charger will reduce its charge voltage in such a way that the voltage drop remains limited to 1V. The reason behind this is, that if the losses are bigger than 1V, the battery cables are too thin and are unable to carry a large current and therefore the charge current needs to be reduced.

Voltage sense can also be used to compensate for voltage losses when diode splitters are used. A diode splitter has a 0.3V voltage drop over the diode.

Some Victron products, like an inverter/charger or large chargers, have voltage sense built in. For other products, such as solar chargers and Smart battery chargers you will need to add a Smart Battery Sense.

If the product has a voltage sense (V-sense) terminal, two wires can be connected from the V-sense terminal directly to the battery's positive and negative terminals. Use a cable with a cross-section of 0.75mm².

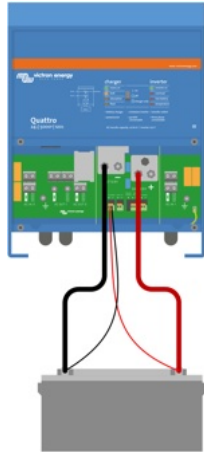

Voltage sensing inverter/charger

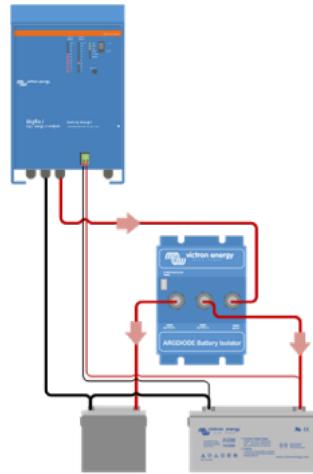

Large charger with voltage sensing and diode splitter

If an inverter/charger is equipped with a VE.Bus Smart dongle, there is no need for voltage sense wires because the dongle takes care of voltage sensing. For more information on the VE.Bus Smart dongle see this link: <https://www.victronenergy.com/accessories/ve-bus-smart-dongle>.

In the case of a solar charger or a Smart charger, connect a Smart Battery Sense to the battery and set up Smart Networking using the VictronConnect app. For more information on the Smart Battery sense see this link: <https://www.victronenergy.com/accessories/smart-battery-sense>.

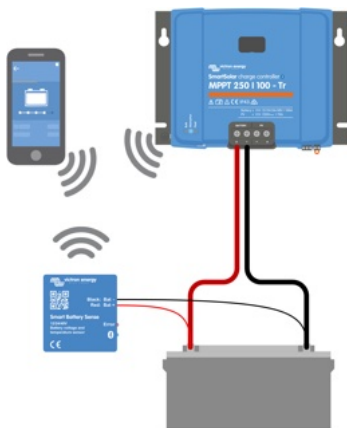

Smart Battery Sense

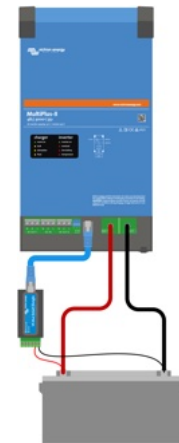

VE.Bus Smart dongle

Voltage sensing in an Energy Storage System (ESS) with a DC solar charger

In an ESS system (Energy Storage System) that only contains DC solar chargers (without grid-feed inverters), the charger of the inverter/charger is disabled. This is because the solar charger charges the battery and excess solar power is fed back into the grid. This process is controlled by the GX device. To make this work, the GX device will set the solar charger at a higher DC voltage than the inverter/charger's DC voltage.

When the battery is almost full, the battery voltage will be slightly higher than the inverter/charger's DC voltage. This is the "cue" for the inverter/charger to reduce this "overvoltage". It does this by feeding power into the grid. In a 48V system, this overvoltage is set at 0.4V, and in a 24V system, this is 0.2V.

For this process to work properly, it is essential that the battery receives the correct voltage from the solar charger. Special care is needed as to the design and placement of the DC cabling, fuses and connections, as they can potentially cause a voltage drop in the system.

A voltage drop can reduce the "overvoltage" the inverter/charger needs before it can feed power into the grid.

Example of an ESS system with a 100A solar charger, two 1-meter 35mm² cables and a 150A fuse:

- The resistance of the connections is 0.35mΩ.
- The resistance of a 150A fuse is 0.35mΩ.
- The resistance of a 2m cable is 1.08mΩ.
- The total resistance is 1.78mΩ.
- The voltage drop at 100A is 178mV

The solution is to use a solar charger with automatic voltage drop compensation (voltage sensing). The result will be that the output voltage of the solar charger will slightly increase with increasing current. But if the solar charger does not have voltage sensing, then it is best to connect the solar charger directly to the inverter/charger.

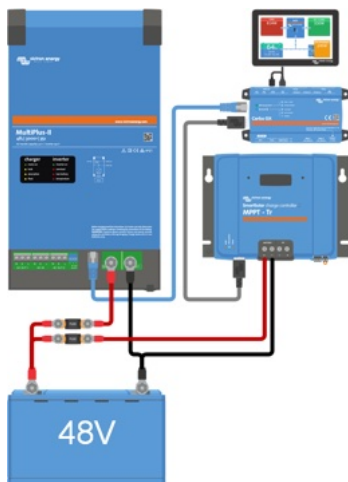

ESS system with a solar charger connected to the battery.

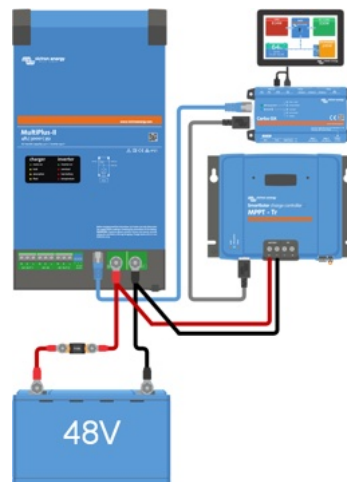

ESS system with a solar charger connected to the battery.

4.12. Solar

Solar panels are not allowed to be directly connected to a battery. A solar charger needs to be placed between the solar panels and the batteries. The solar charger converts the higher solar panel voltage into a voltage suitable for battery charging. If a solar panel is connected directly to a battery, the battery will get damaged.

Safety:

Depending on local regulations, a fuse, circuit breaker, RCD or GFCI might need to be installed between the PV array and the solar charger.

MC4 connectors:

To connect solar panels to a solar charger the solar panel is in most cases fitted out with special waterproof connectors, commonly these are MC4 connectors. These connectors come in 2 varieties, a male connector and a female connector.

The male connector connects to the positive cable coming from the solar panel and the female connector connects to the negative cable.

In case the solar cables are not long enough, an extension cable will need to be used. The extension cable is often pre-assembled with MC4 connectors. A solar cable is fitted out with a male connector on one end and a female connector on the other end. Like this:

MC4 connectors can be connected to 4mm² or 6mm² solar cables.



Solar cable. On the left is the male MC4 connector and on the right is the female MC4 connector.

Solar cable types:

A solar cable is a special cable. It is a very tough cable and has been designed for outdoor use in solar panel installations. It is dust, age and UV resistant and has tinned copper wire strands.

A solar cable for small PV arrays, like for Automotive or marine applications is often a dual-core cable. Again, the same applies to these installations, the cable must be UV rated and will need to have tinned copper wire strands.



A solar cable for small PV arrays, like for Automotive or marine applications is often a dual-core cable. Again, the same applies to these installations, the cable must be UV rated and will need to have tinned copper wire strands.

Cable thickness:

The cable thickness of the solar cable depends on the size of the solar array and what voltage it has. This will determine the current and this will determine cable thickness. Please see chapter [Cable selection \[21\]](#) for more information on this.

Connecting to a solar panel:

Solar chargers are sold in two models, with either MC4 connectors or with screw connectors on the PV side. This is how to connect them to a solar panel as seen from the rear of the solar panel:

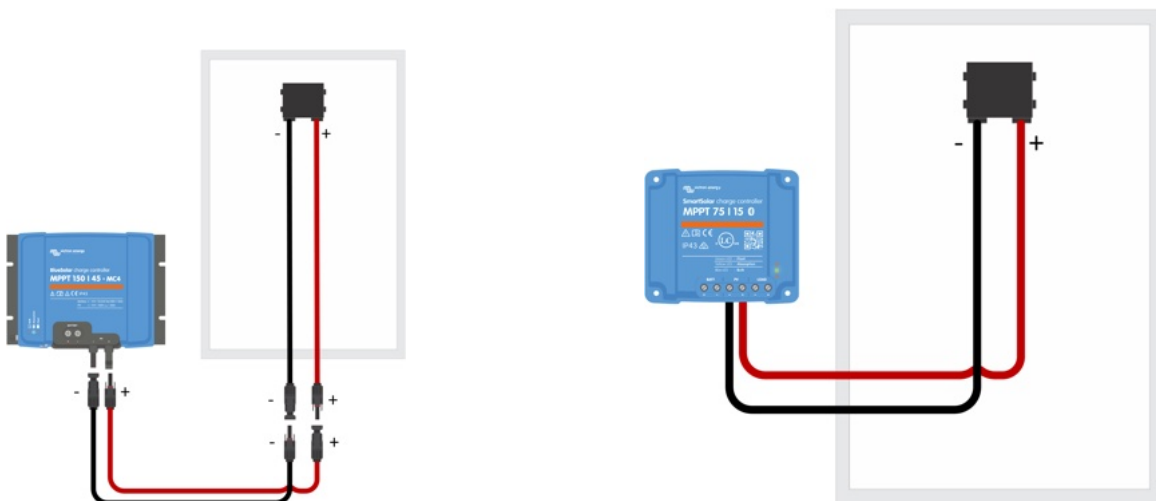

Solar charger with MC4 connectors.

Solar charger with screw connectors.

In some occasions, the solar panel does not have cables attached. You will then need to attach these yourself. To do this, open the junction box at the rear of the panel and connect the cables there. You can either use solar cables with or without MC 4 connectors. If you are wiring the solar panel directly to the solar charger, then this is what the installation will look like:

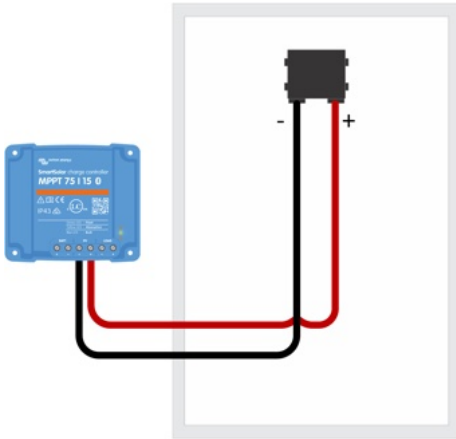

Connecting a solar charger to a solar panel without using MC4 connectors.

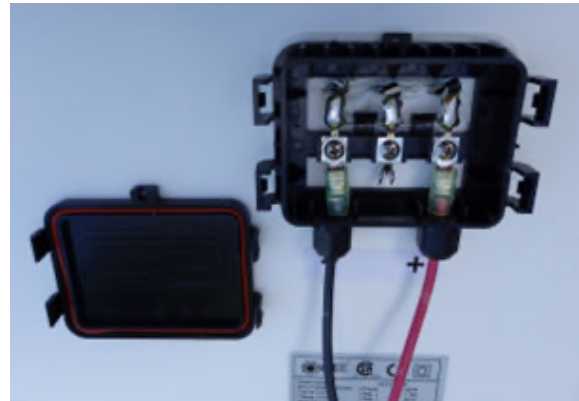

Solar panel junction box.

Solar arrays:

In many solar installations, one solar panel is not enough. If this is the case, a solar array or photovoltaic (PV) array needs to be created. A Solar array consists of multiple solar panels that are connected together.

If you connect solar panels in series the voltage increases and when you connect them in parallel the current increases. The same is the case when constructing a battery bank with individual batteries.

MC4 splitters:

To make parallel connections easy, use MC4 solar splitters. There are two types:



MC4-Y - 1 male and two female.



MC4-Y - 1 female and 2 male.

Solar array wiring examples

Some solar array wiring examples that show panels wired in series, parallel and series/parallel using MC4 splitters.

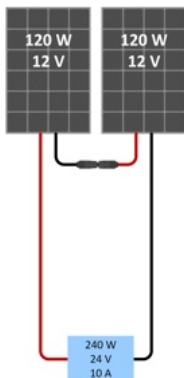

Series solar array.

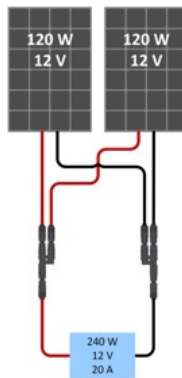

Parallel solar array.

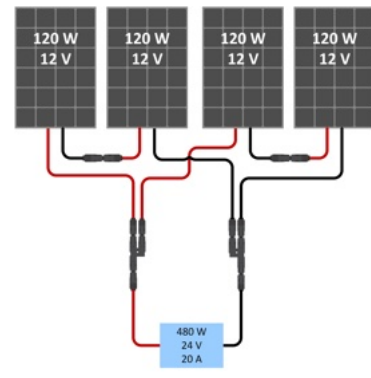

Series/parallel solar array.

Solar array total power

To determine the total power of a solar array, you will simply have to add the power of each module no matter if they are connected in parallel or in series:



200W solar array.

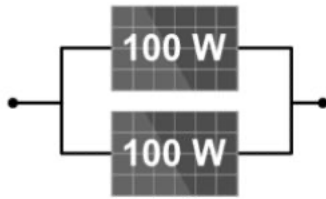

200W solar array.

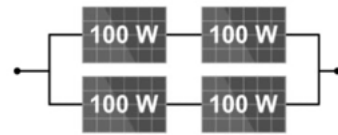

400W solar array.

Solar array total voltage:

When designing a solar array, you will need to make sure that the array's open circuit voltage (Voc) does not exceed the voltage rating of the MPPT. For some extra information on designing a solar array:

An example of array voltage when panels are connected in series:

If you look at the specs of a 12V solar panel, you will find that the Voc is around 22V. For a 75/15 MPPT solar charger, the solar voltage can be as high as 75V. This will allow you to connect up to 3 x 12V panels in series.

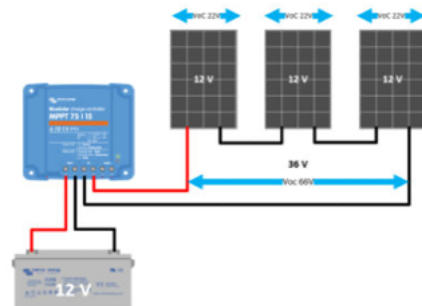

Note on MPPT charge current at different battery voltages:

Example: For a 75/15 MPPT solar charger, the current rating is 15A. This is the current going into the battery. This means that with a 12V battery you will get less power into the battery than with a 24V battery.

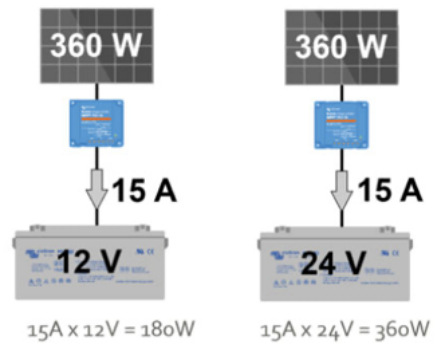

To help you design a solar array and to match it to the correct solar charger:

Use the Victron MPPT sizing calculator, see here: <https://www.victronenergy.com/solar-charge-controllers>.



5. Communication wiring

Equipment in modern systems needs to be able to communicate, either with each other or with a control or monitoring device. To make communication happen, communication cables are required. They send information from one piece of equipment to another piece of equipment. Quite often, these are mission-essential communications. If the cable fails, the communication stops, and the system might stop operating.

Some examples of communication cables used in inverter/charger systems:

- Communication cables between multiple inverters or inverter/charger units to create a parallel and/or 3-phase system.
- Communication cables to control equipment, for example, between a solar charger and the Color Control GX or another GX device.
- Communication between a measuring device and a monitoring device, like the BMV shunt and the BMV head unit, or between a temperature sensor and an inverter/charger.
- Internet or network cables.
- Two wire signal or control cables, for example, between an alarm relay and a generator auto start, a car ignition switch and a DC/DC converter, or between a battery BMS and a BatteryProtect.

5.1. Data signals

A data signal is a signal that constantly changes in line with the information it sends. It can be analogue or digital.

The signals in communication cables can be any of these types. These signals have a low voltage and current. Often no more than 5V.

The different signal types:

- Analogue signal: The voltage can have any value, and there is a direct correlation between voltage and value.
- Digital signal: The voltage of the signal is limited to a finite set of voltages.
- Binary signal: There are only two voltage values. The signal represents an on/off condition or is used to transmit data by sending strings of ones and zeros.

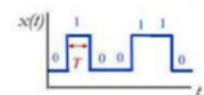

5.2. Interference

Like with all cabling, it is important that the communication cables are of good quality. Also, their connectors need to be of good quality and that they have been crimped on the cable correctly. It also matters how good the connection to the receiving socket is.

Communication cables carry low voltage signals of low current. If these signals travel over a distance, of course, a voltage drop can occur, but that is not so common, because these signals only carry a very low current. A voltage drop will not normally be an issue unless the cables are very long.

However, another aspect is critical for communication cables when low voltage signals are sent over a long distance and that is interference.

The different interference types and what they are caused by:

- Electromagnetic interference - from generators, transformers, electro motors and knife switches.
- Radio frequency interference - from radio transmitting sources, radar and badly shielded equipment.
- Electrostatic interference - from static electricity.
- Cross talk interference – interference from nearby cables.
- Common interference – caused by current flowing between different potential grounds in a system.

In the first 4 cases, the cable acts as an antenna and it receives this interference. The interference induces additional electricity into the communication cables. This will change the voltage of the signal resulting in an alteration of the data that is being sent and will cause confusing or disrupted communication.

In really bad cases, where there is a lot of interference or a grounding issue, the voltages in the cable can become so high that it causes damage to the communication circuitry in the equipment that connects to the communication cable.

There are ways to limit or prevent interference, these are:

- Keep cables short.
- Use twisted pair cables.
- Use shielded cables.

Unshielded and untwisted cables:

These cables are very susceptible to interference. And because of this, they have a length limit. This is approximately 10 meters. This is why we do not sell VE.Direct cables longer than 10 meters. The VE.Direct cable is unshielded and untwisted cable.

*Unshielded untwisted.***Twisted pair cables:**

Two conductors of a single circuit are twisted together. This will improve the rejection of electromagnetic interference and it also will make the cable less susceptible to cross-talk from neighbouring cables.

*Unshielded twisted pair.***Cable shielding:**

A metal foil or braid covers a group of cables or might even cover twisted pairs.

*Foil shield**Braid shield**Multi shield*

5.3. Communication cable types

This paragraph contains a short selection of commonly used communication cable types as used in inverter/charger systems.

Communication cable types:

RJ45 straight UTP cable:

This cable is used for computer networks, internet, and ethernet, but they are also used for inverter/chargers to communicate to each other and to a control product, like the Multi Control panel or a GX device.

This cable has 8 conductors. In a straight cable pin 1 on one side connects to pin 1 on the other side, pin 2 connects to pin 2 and so on.

To test if the cable is wired correctly use a cable tester. Victron uses this cable for VE.Bus and VE.Can products. It was also used for the, now deprecated, VE.Net products.

In the past, these cables usually had a blue colour, but more different colour cables have recently appeared. Victron manufactures different length cables as do other manufacturers. For more information see: <https://www.victronenergy.com/cables/rj45-utp-cable>.

It is not recommended to make these cables yourself. A badly crimped connector can be the cause of hard-to-diagnose system faults.

To test an RJ45 cable, first, replace the cable and see if the problem has gone away. Another source of faults is when the male RJ45 connector is not properly inserted into the female RJ45 socket or when the RJ45 sockets contacts have lost their springiness and do not make good contact anymore.



Be aware of RJ45 cross-over cables. They look like a regular "straight" RJ45 UTP cable. These were used in old computer networks or used by other inverter manufacturers. It can be very off-putting in case one of these cables are used where a straight cable should have been used. These cables cannot be used for Victron equipment.

Some Victron products have only a single RJ45 connector, in that case use an RJ45 splitter. For more information see: <https://www.victronenergy.com/cables/rj45-splitter>.

**RJ45 Terminator:**

Used to terminate a daisy chain CANbus network. One terminator is placed at the first item in the chain and one at the last item in the chain. They ship as a pair, since a VE.Can system always need two terminators. For more information see: <https://www.victronenergy.com/accessories/ve-can-rj45-terminator>.





**RJ45 cable with special pinout:**

They look like regular "straight" RJ45 UTP cables, but they have been rewired to serve a specific purpose. These types of cables are for special applications. They often only have a unique application. In the case of Victron they are used between a smart battery and a Color Control GX or other GX device. Cable labelling is very important. The label needs to indicate how the cable is internally wired. This means that at a later stage these cables do not end up in a regular system, where they can potentially cause a communication fault. For more information see: <https://www.victronenergy.com/cables/ve-can-to-can-bus-bms>.

**RJ12 UTP cable:**

These are used between the BMV shunt and the BMV head unit. This is a cable with 6 conductors. These cables are normally used to send digital data but the BMV uses it to send analogue data. The BMV is supplied with one of these cables. Victron manufactures cables of various lengths, choose one of these if a bespoke cable is needed. As with the RJ45 cable, only use pre-manufactured cables. We do not recommend that you make this cable yourself. Too often a badly crimped connector is the cause of a hard to diagnose strange system behaviour. Cables with RJ12 connectors are also commonly used for telephones. But in case of a telephone cable not all 6 wires are present. Also, the phone cable is not twisted pair. They cannot be used for a BMV. For more information see: <https://www.victronenergy.com/cables/rj12-utp-cable>.





<p>VE.Direct cable:</p> <p>This is 4 core data cable. This is a special cable for monitoring or control of certain Victron products like a BMV or MPPT. For more information see: https://www.victronenergy.com/cables/ve.direct.cable.</p>	
<p>Signal or hook-up wire:</p> <p>This is mostly a thin wire, usually no thicker than 1.5mm². They come as cable in a variety of colours and with single, double or multiple conductors. These cables typically carry low current analogue signals or on/off signals.</p> <p>For marine applications use hook-up wire with tinned copper strands.</p>	
<p>NMEA2000 cables and connectors:</p> <p>Used in marine CAN-bus data networks. This cabling consists of special marinated data cable and waterproof connectors, T pieces and terminators. For more information see Wikipedia.</p>	
<p>RS485 cables:</p> <p>Used for serial communications. In the case of Victron, it is used for communication between energy meters and a GX device. For more information on RS485 see Wikipedia.</p>	
<p>USB cables:</p> <p>Available in a variety of types. Victron mainly uses the type A connector. For more info on USB see Wikipedia.</p>	

5.4. Interfaces

Interfaces are small devices that translate one data protocol to another data protocol. They are often wired into a cable or are located at one end of a cable.

Some Victron specific interface examples:

<p>MK3 to USB interface:</p> <p>It is used to connect a computer to a VE.Bus product. The MK3 had replaced the MK2 interface. The MK2 can still be used, but it is not recommended. Seriously consider upgrading to an MK3.</p> <p>For more information see: https://www.victronenergy.com/accessories/interface-mk3-usb</p>	
<p>VE.Direct to USB interface:</p> <p>It is used to connect a computer to a VE.Direct product or used to connect a VE.Direct product to a GX device USB port.</p> <p>For more information see: https://www.victronenergy.com/accessories/ve-direct-to-usb-interface</p>	
<p>RS485 to USB interface:</p> <p>It is used to connect an energy meter to a GX device.</p> <p>For more information see: https://www.victronenergy.com/accessories/rs485-to-usb-interface</p>	
<p>VE.Can to NMEA 2000 micro-C male cable:</p> <p>It is used to connect a VE.Can product to an NMEA 2000 network.</p> <p>https://www.victronenergy.com/accessories/ve-can-to-nmea2000-micro-c-male</p>	

For the full range of Victron interfaces, see the Victron accessories product page at: <https://www.victronenergy.com/accessories>.

6. AC wiring

This chapter covers AC electricity generation, distribution, cable sizing and the AC wiring of inverter/charger systems.

6.1. Power generation

The generator in a power station generates 3-phase electricity.

Each of these 3 phases has an alternating voltage of 230 Volt (or a different voltage, depending on the country). The voltage alternates at a frequency of 50 (or 60) Hz. And because the coils in the generator are rotating, there is a 120° phase shift between each phase.

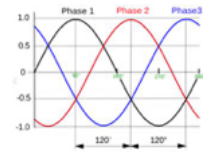

The 3 coils are connected to each other and create a triple circuit, a so-called star configuration. A single coil (phase) has a potential of 230Vac. And a second potential level is created between two coils. Due to the 120° phase shift, the potential is 400Vac.

To be able to use the phases separately the common point (star point) is connected to a conductor called "neutral". Between the neutral and one of the phases a voltage of 230Vac exists. The Neutral conductor is a conductor that can be used by all 3 phases and can be used in 3 separate electrical circuits.

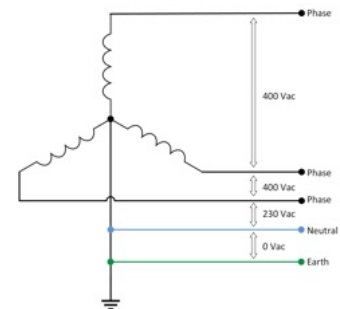

The star point acts as a neutral in an electrical house installation. The function of the neutral conductor is to enable separate use of each phase and each phase can be used as an individual 230Vac supply. The neutral is also connected to a metal spike driven into the ground, the so-called earth spike. In this way, the potential of the earth equals 0 Volt. This connection is called earth.

A 3-phase load, like a 3-phase electric motor, uses electricity from all 3 phases. The neutral does not have a function because the 3 electrical circuits will keep each other balanced. Only if one of the phases consumes more load than the others, the neutral will start to conduct current. This current is called the "compensating or equalizing current".



When setting up 3-phase inverter/chargers they will need to be set up in a star configuration. They need to have a common neutral. Delta is not allowed. But the 3-phase inverter/charger system can power a "delta" configured load.

Unequal loading is not an issue when the inverter/chargers are operating in inverting mode, but it might be an issue if they are operating in pass-through mode and are connected to a generator that is unable to deal with an unbalanced load.

6.2. Distribution networks

There are different ways in which power is distributed to the consumer. And different ways in how the consumer system is connected. All networks supply the 3 phases, but the way neutral and earth are bonded varies per network type.

TN-S network

- The generator star point is connected to neutral and to earth.
- The phases, neutral and earth are distributed.
- The consumer uses the supplied phases neutral and earth.
- Neutral and earth are not connected to each other.

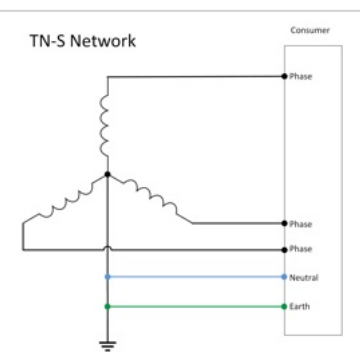

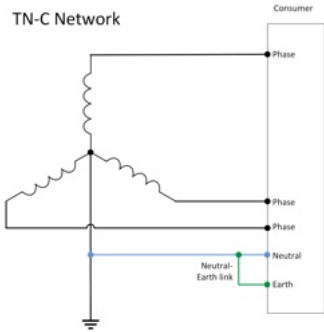
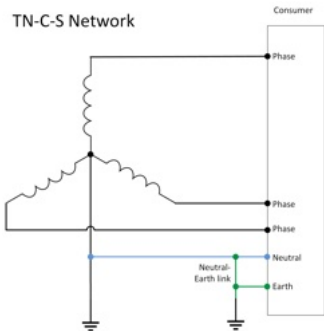
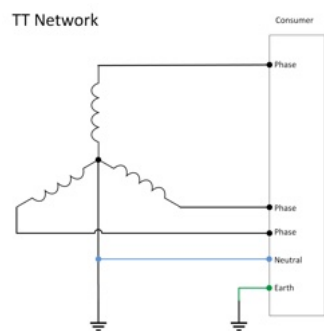
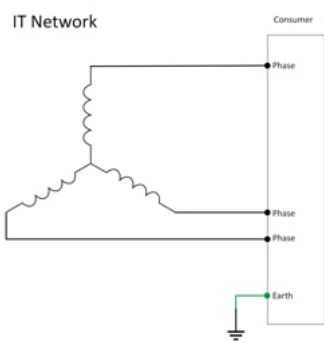
<p>TN-C Network</p> <ul style="list-style-type: none"> • The generator star point is connected to neutral and to earth. • The phases and a combined neutral-earth are distributed. • The consumer splits up the incoming neutral and earth (MEN link). • The consumer uses the supplied phases and the newly created neutral and earth. 	
<p>TN-C-S Network</p> <ul style="list-style-type: none"> • The generator star point is connected to neutral and to earth. • The phases and a combined neutral-earth are distributed. • The consumer splits up the incoming neutral and earth (MEN link). • The consumer connects the earth to an earth stake. • The consumer uses the supplied phases and the newly created neutral and earth. 	
<p>TT network</p> <ul style="list-style-type: none"> • The generator star point is connected to neutral and earth. • The phases and neutral are distributed. • The consumer uses the supplied phases and neutral. • The consumer creates a local earth via an earth stake. 	
<p>IT network</p> <ul style="list-style-type: none"> • The generator star point is not connected to neutral and earth. • The phases are distributed. • The consumer uses the supplied phases. • The consumer creates a local earth connection. 	

6.3. System current, VA and Watts

To be able to correctly calculate fuses, wiring size or inverter size, you will need to know how large the current in the AC circuit is. To be able to correctly calculate the current, there is one aspect of AC power that will need to be explained, namely Watt and VA. Like explained before, AC power is alternating power. Both the voltage and the current do not have a constant value like DC, but they alternate from positive, to negative, to positive and so on. This happens 50 times a second in a 50 Hz system and 60 times per second in a 60 Hz system. The waveform is a sine wave.



DC voltage



AC voltage

Not only the voltage alternates in an AC circuit, the current also alternates. In a resistive system they alternate at the same time. However, if the circuit contains non-resistive loads, the current sine wave can lag behind the voltage sine wave, or be in front of the voltage sine wave. The three different types of loads are:

- Resistive loads are loads with resistive elements, such as: heaters, incandescent light globes, toasters, hair dryers and so on.
- Inductive loads are loads with coils, like electromotors or transformers. Examples are: refrigerators, compressors, air conditioners, fluorescent lights.
- Capacitive loads are loads that contain capacitors, examples are capacitor banks, start motors, battery chargers, UPS devices.

Below images depict the behaviour of the voltage (red) and current (blue) in an AC circuit with different types of loads:

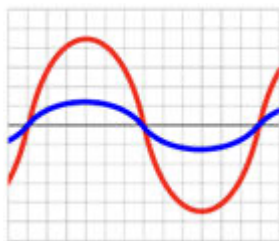

Resistive load

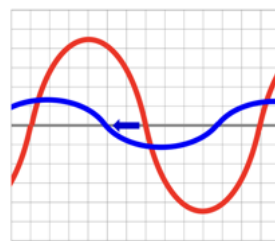

Inductive load - passive

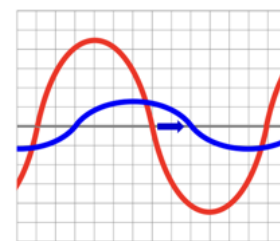

Capacitive load - reactive

Watt is the real power drawn by the equipment. The power rating in Watt determines the actual power purchased from the utility company, the diesel consumed by a generator or the heat loading generated by the equipment.

VA is the “apparent power” and is the product of the voltage times the current drawn by the equipment. The VA rating is used for sizing wiring, circuit breakers, inverters or generators.

In a purely resistive AC circuit, voltage and current waves are in step (or in phase) with each other. To calculate current this formula can be used:

Current = Power/Voltage
 $I = P/V$

The power factor is 1 in a purely resistive system. When an AC circuit contains loads such as inductors or capacitors, a phase shift will occur between the current and voltage waves. Both these waves are not in step (in phase) anymore.

Looking at the waves, if you calculate the power you will see that the True power (W) is less than the apparent power (VA).

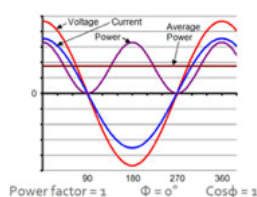

Power factor = 1

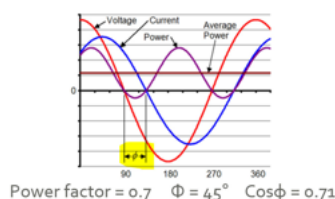

Power factor = 0.7

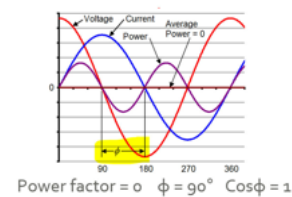

Power factor = 0

When the power factor is known the apparent power can be calculated.

$$W = V \times A \times \text{Power factor}$$

$$\text{True power} = \text{Apparent power} \times \text{Power factor}$$

On average a residential AC circuit has an average power factor of 0.8. So, for general calculations, it is okay to use 0.8 as the power factor.

Non-Linear loads:

Then there is one more type of load, the non-linear load. To put it simply, these are loads that do not load up the whole sine wave equally, or they might only use a part of the wave. The current drawn by the non-linear load will not have a sine wave shape, although the load is connected to a sine wave voltage.

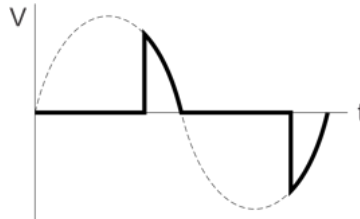

Example of a non-linear load. Only part of the voltage is applied to the load.

These often are loads that contain semiconductors, like diodes, thyristors or LEDs. Examples of these are AC LED lighting, light dimmers, heat guns, rectifiers and certain soft start devices.

When an inverter powers a non-linear load, it may experience an overload situation sooner than expected based on the power rating of the load and the inverter.

6.4. AC cabling

In a house or factory installation, the incoming electricity is divided into groups, usually on a distribution board. The diameter of the electrical wiring for each AC circuit (group) must be matched to the size of the expected maximum current in that circuit. This is to protect the connected loads and the electrical wiring.

Voltage drop and heating of cables can also occur in AC circuits. Voltage drops can damage the connected appliance and cause heating up of cables, and in extreme cases, can lead to house fires.

It is also essential to make good cable connections. Bad cable connections can also lead to voltage drop and heating. Use the guidelines as already described earlier.

Do not use rigid AC wires:

Avoid connecting the inverter/charger to wires with rigid strands (as shown in the image on the right).

Wires with rigid strands are not suitable for the inverter/charger AC connectors, leading to poor contact and the risk of disconnection. Use wires with fine and flexible strands instead.

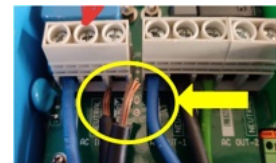

Rigid AC wires that have come loose.

Wiring sizing:

The [Victron Energy Toolkit app](#) also has a provision for calculating AC wiring for 120, 240 and 400Vac systems. When using the app, the aim is to select a wire size so that the voltage drop stays below 2.5%.

For wiring calculations, you can use similar calculations as for DC wiring, as already explained. But be aware that the earlier mentioned rule of thumb cannot be used. For wiring for voltages from 200 to 400Vac, use this rule of thumb:

- The required core surface area in mm² is derived by dividing the nominal current by 8.
- Add 1mm² for every 5 meters of cable length.



Please be aware that the "rule of thumb" might not meet your local AC wiring standards. It is meant to be used as a guide only.

6.5. AC fuses and circuit breakers

Fuses are generally located on the distribution board. Each AC circuit (group) is fused separately. The fuse is matched to the size of the expected load and to the cabling thickness.

The fuse protects against:

- Overload - when more current runs in the system than can be normally expected.
- Short circuit - when the phase conductor accidentally comes in contact with Neutral or Earth.

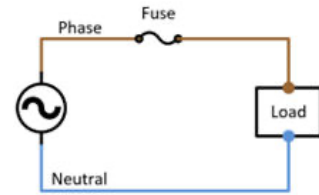

Traditionally, a fuse contains a wire that melts when an unacceptable current passes through it. As soon as the wire in the fuse has melted the electrical circuit has been broken and no additional current will flow.

More commonly automatic circuit breakers are used to protect against overcurrent. These are called Miniature Circuit Breaker (MCB). This device has two triggers for activating its switch-off mechanism. A thermal trigger for long-term small overload currents, and a magnetic trigger for large short duration currents like short circuit currents.

MCBs come in three types: B, C and D. They all have the same thermal characteristics. But they have different short circuit current levels.

- Type B disconnects at $5 I_n$ (5 rated currents) and is commonly used as a household MCB
- Type C disconnects at $10 I_n$ and is used for transformers and fluorescent lamps.
- Type D disconnects at $20 I_n$ and is used for large motors, transformers and mercury lamps.

When a short circuit current occurs, with sufficient current, the MCB (B, C or D) is switched off within 100ms.

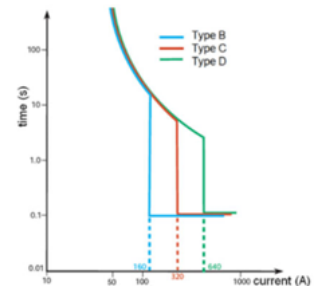

6.6. AC bypass switch

It is recommended to add a manual bypass to an inverter/charger system. This is especially useful in mission-critical systems. This will allow you to bypass the inverter/charger and connect the AC input (grid or generator) directly to the loads. It will prove invaluable in case the inverter/charger needs a configuration change or should anything go wrong with the inverter/charger and directly connect the AC input (grid or generator), if it needs to be removed for service.

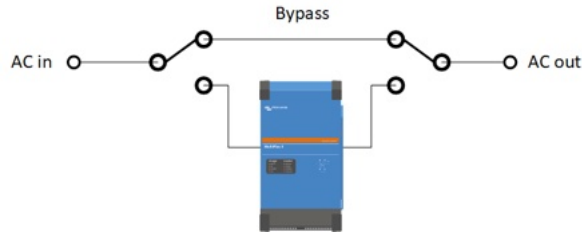

The functionality of a bypass switch.

To create the bypass, the AC paths to and from the inverter/charger needs to be interrupted, and a separate bypass circuit needs to be established. The bypass needs to be rated to the full AC load of the system.

The manual bypass can be constructed using two changeover switches. An example of a suitable changeover switch is the Hager SF263 2 pole changeover switch with a centre-off position.

The below diagrams show how the changeover switches are wired in the system and the 3 switching possibilities.

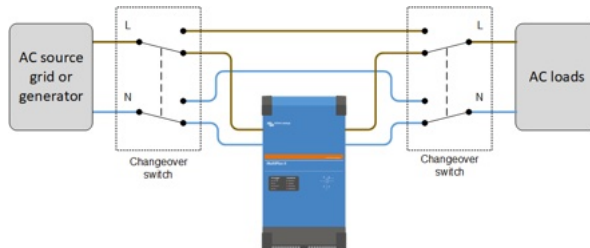

The inverter/charger is connected and the bypass is disconnected.

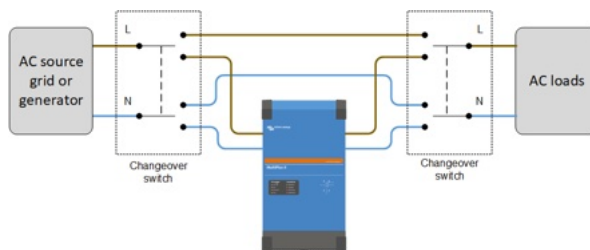

The inverter/charger and the bypass are both disconnected.

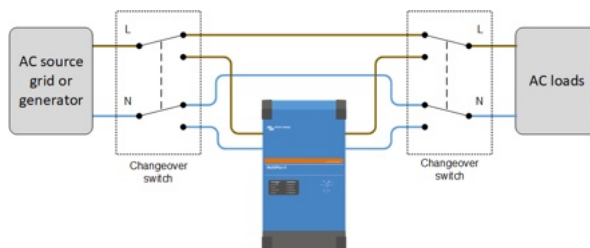

The inverter/charger is disconnected and the bypass is connected.

In case a low-power inverter/charger is used, like the MultiPlus Compact or the Multiplus 500 to 2000VA, it is easy to manually bypass the inverter/charger. Simply pull the black AC in and AC out plugs out of the inverter/charger and insert these plugs into each other.



MultiPlus Compact AC plugs

6.7. Special considerations AC wiring parallel inverter/charger systems

Multiple inverter/chargers can be connected in parallel to create a larger inverter/charger. When connecting a parallel system to an AC supply it matters what length and thickness the AC wires have. Unlike DC cabling, for AC cabling it is important to not make the cables too short or too thick. Do not over-dimension the AC cabling. Using extra-thick cabling has negative side effects.

In a parallel system, each inverter/charger should be identical. However, this is not always the case. Each inverter/charger contains an internal AC input contactor. These contactors are not always completely identical, they can have a small difference in their internal resistance, compared to the other contactors. This small resistance difference might result in the AC current being diverted from one unit to another.

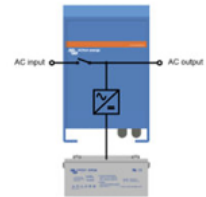

Example of the internal wiring of an inverter/charger.

In a parallel system, the AC current should be evenly distributed through all paralleled inverter/charger units. When the resistance in the cabling is very low, the small difference in contactor resistance will result in a large relative difference. And this will cause unequal current distribution.

An exaggerated example:

Unit A and unit B are connected in parallel. Extremely thick and short cabling is used so that a very low wiring resistance was created. But, the two units have a slight internal (AC contactor) resistance. See the image on the right.

In this scenario, the total resistance for unit A is 0.1mΩ and the total resistance for unit B is 0.2mΩ.

This will result in Unit A carrying twice as much current as Unit B.

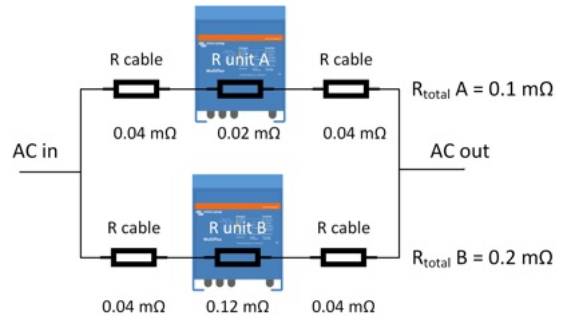

Now, we use the same 2 units in parallel, but we use thinner and longer cables. See the image on the right. The total resistance for unit A is 1.5Ω and the total resistance for unit B is 1.6 Ω. This will result in a much better current distribution.

Unit A will carry only 1.066 times more current than unit B.

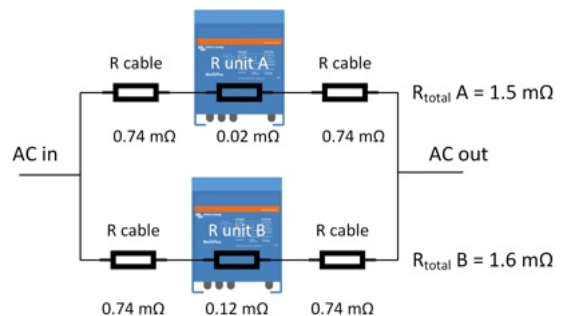

Preventing uneven distribution of AC currents:

To safeguard against this issue, it is recommended to use long AC cables, of similar length. Always follow the recommended cable lengths and thicknesses as listed in the product manual. Do not increase the cross-section of the AC cabling more than is recommended in the manual!

For example:

The voltage drop tolerance of a 100 A back feed contactor is about 20 mV at 100 A. The total cable resistance (input + output) should therefore be larger than $R = 60 \text{ mV}/100 \text{ A} = 6 \text{ m}\Omega$.

Checking for even distribution of AC currents:

The best way to check if this type of wiring issue is affecting a parallel system is the following:

- Fully load the system.
- Measure (current clamp) the AC current for each individual current.
- Compare the currents.

The current readings should be very similar. If there are big differences, then there is an issue with wiring (or with a connection).

AC fusing parallel strings:

Each unit needs to be fused individually. Make sure to use the same type of fuse on each unit due to the same resistance. Consider using mechanically connected fuses

More information:

For more info on parallel and 3 phase systems please read the Parallel and 3-phase manual, see https://www.victronenergy.com/live/ve.bus:manual_parallel_and_three_phase_systems

6.8. Phase rotation 3-phase inverter/charger systems

Phase rotation:

The 3 phases L1, L2 and L3 of a 3-phase supply need to be connected in numerical order. Pay special attention to the phase rotation of the AC supply from the grid or from a generator. When wired in the wrong rotation, the system will not accept the mains input and will only operate in inverter mode. In that case swap two phases to correct it. A quick way to fix phase rotation is to swap 2 random phases and see if now the inverter system will accept AC in.

In case the system is mobile it is likely that, at some point, there will be a generator or grid connection with incorrectly wired phase rotation and the inverter/charger system will reject the input and stay in inverter mode, consequently draining the batteries. Mounting a simple changeover switch that can swap two of the phases is a nice solution that instantly fixes the phase-rotation issue, without stalling the event. Besides manual switching, there are also automatic devices available to do this.

For more info on parallel and 3 phase systems please read the Parallel and 3-phase manual, see https://www.victronenergy.com/live/ve.bus:manual_parallel_and_three_phase_systems

7. Ground, earth and electrical safety

Ground or earth provides a common return path for electric current in an electric circuit. It is created by connecting the neutral point of an installation to the general mass of the earth or a chassis. Grounding is needed for electric safety and it also creates a reference point in a circuit to which voltages are measured.

Generally speaking, there are 3 types of grounding, namely:

- A. Earth
- B. Chassis earth
- C. Ground

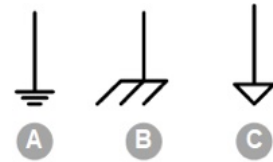

- **Earth** is a direct physical connection to the Earth. This is usually done by driving a copper rod (earth stake) into the ground. But, depending on age and location of the system this can also be a copper plate or copper strip buried in the ground, or the water mains or water pipes in a house.
- **Chassis earth** is a connection to a metal frame such as that of a vehicle or the metal hull of a boat. It can also be the metal case of electrical equipment.
- **Ground** is a common reference point in a circuit to which voltages are measured. As a result, a voltage may be above ground (positive) or below ground (negative).



7.1. Electrical safety

Electricity is dangerous, it can kill, injure or burn a person. It is the current that is the most dangerous part of electricity. A small current running through a person can already be very dangerous. See the below table.

Electric current (1-second contact)	Physiological effects
1mA	Threshold of feeling a tingling sensation.
5mA	Accepted as maximum harmless current.
10 - 20mA	Beginning of sustained muscular contraction ("can not let go" current).
100 - 30mA	Ventricular fibrillation, this is fatal if continued. The respiratory function continues.
6A	Sustained ventricular contraction followed by normal heart rhythm (defibrillation). Temporary respiratory paralysis and possibly burns.

Current will flow as soon as an electric circuit is closed. For example, imagine two loose AC wires, a live and a neutral wire. When the wires are just hanging there, no current will flow because the circuit is not closed. But as soon as you touch a live wire with one hand and the neutral wire with another hand you have closed the circuit and electricity will flow from the live wire, via your body and via your heart, back to the Neutral wire. The current will keep flowing until the fuse blows, but by then you are probably already dead.



Exposed electrical wires.

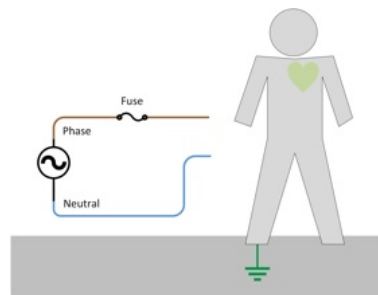

The electric circuit is not closed and electricity cannot flow.

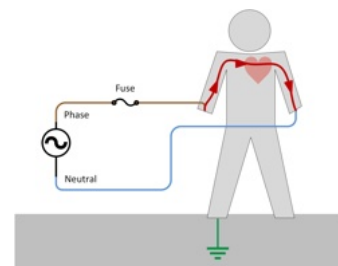

The electric circuit is closed and electricity will flow.

Apart from touching a neutral and a live wire at the same time, there is another way in which an unsafe situation can occur and that is when the electricity flows via earth. This is a more common situation to occur, than someone touching a phase and neutral conductor at the same time. The neutral conductor is connected to earth at some point. This can be in the house installation, in the distribution network or at the power generator (the star point).

If there is a fault in electric equipment the metal parts of the outside of that equipment can become live. This can be because there is an internal shortcut between live electricity and the equipment's metal housing. Think for example of a faulty washing machine. A fault can have been caused because there is an electrical fault, mechanical damage, or damaged electrical wires that are touching the metal housing of the electrical equipment.

The moment you touch the faulty washing machine, electricity will flow from phase to the metal housing, via you, to earth. From the earth, the electricity will then flow into the Neutral of the mains supply. The circuit is complete. Electricity will keep flowing until the fuse in the mains supply has blown. But like in the previous situation, you are probably already dead.

To make electrical installations safer the earth conductor was introduced. The earth wire connects the metal housing to earth.

If you now touch the faulty equipment, electricity will flow into the earth wire rather than into you. The reason for this is that electricity will travel through the path of least resistance. The path via you and the earth is a more resistive path than via the earth wire. But be aware that a very small amount of current can still flow via a person. A current greater than 30 mA can already be dangerous.

Note that just an earth wire is not enough. A residual current device (RCD) is also needed in an installation. See chapter [RCD, RCCB or GFCI \[58\]](#) for more information.

7.2. Earth wiring

Good earth wiring is essential to electrical safety. The wire and the earth connections must be of low electrical resistance. Remember that electricity will travel through the path of least resistance. So, you have to make sure that the earth cable is thick enough and all connections are tight.

The earth wire can have potentially large currents flowing through it when there is an equipment fault. The earth wire needs to be able to carry this current until the system fuse blows. So it is important that the earth wire is thick enough.

Earth or ground wires are yellow/green. In older installations or in different countries you might also see a green wire.

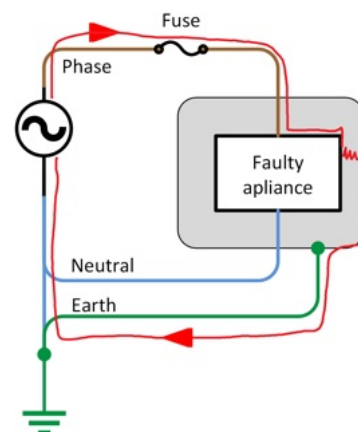

CAUTION: Always follow the local wiring regulations for the correct earth wire sizing.

7.3. RCD, RCCB or GFCI

Electricity can be very dangerous. Adding an earth conductor into a system improves safety, but an installation can be made even safer by incorporating an RCD (residual current device).

The use of an RCD is compulsory in all AC installations.

RCD function:

The RCD detects and disconnects as soon as it detects that electricity is flowing into earth. Electricity will flow into earth if there is a fault in the system, or more importantly when current is flowing through a person. RCDs are designed to disconnect as soon as a current flow to earth is detected.

A residual current device (RCD) can be known under different names:

- Residual current circuit breaker (RCCB).
- Ground fault circuit interrupter (GFCI).
- Ground fault interrupter (GFI).
- Appliance leakage current interrupter (ALCI).
- Safety switch.
- Earth leakage device.

RCD operation:

An RCD measures the current balance between the phase and the neutral conductor. The device will open its contact when it detects a difference in current between phase and neutral.

In a safe system, the supply and return currents must sum to zero. If this is not the case there is a fault in the system, current is leaking to earth or to another circuit.

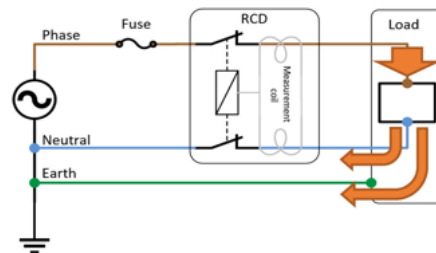

RCDs are designed to prevent electrocution by detecting this leakage current, which can be far smaller (typically 5 - 30mA) than the currents that are needed to trip conventional circuit breakers or fuses (several Amperes). RCDs are intended to operate within 25 - 40 milliseconds. This time is faster than the time needed for the electric shock to drive the heart into ventricular fibrillation, the most common cause of death through electric shock.

A safe system is a system that protects against short-circuit, overload and earth leakage currents.

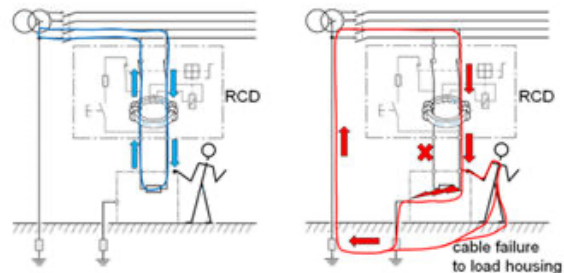

Earth leakage detection can only take place in systems where the neutral conductor is connected to the earth conductor; like in a TN or TT system. Earth leakage detection is not possible in an IT network.

Where to mount an RCD

An RCD must be mounted before the loads in an electrical installation. In reality, this means that the RCDs have to be mounted before the installation is split up into different groups. If an inverter or inverter/charger is used, the RCD should come after this, otherwise, there will be no earth protection while the inverter is operational. Consumers that are only operational when connected to shore power will need their own RCD.

Nuisance Tripping of RCDs

In some installation RCD's will trip prematurely. This can be caused by the following:

- The system has a double MEN (neutral to earth) link, this will cause the RCD to trip due to a potential difference in earth.
- The system contains equipment that introduces a small 'below threshold' amount of neutral earth leakage, and the cumulative effect of that can cause unpredictable nuisance tripping of RCD's. Some common troublesome appliances to check and disconnect first when troubleshooting are: surge Protected Power-boards, old refrigerator compressors and electric hot water units (due to their own earth differential from the main earth stake).

7.4. Neutral to earth link in inverters and in inverter/chargers

An AC power source needs to have a neutral-to-earth link (MEN link) so that an RCD can operate. This is the case for the grid, but also if the AC source is a generator or an inverter.

- If the AC power source is the grid, the MEN link will have been hard-wired in the switchboard where the grid enters the installation.
- If the AC power source is a generator, the MEN link will have been hard-wired in AC connection terminals of the generator.
- If the AC power source is an inverter, the MEN link will have been hard-wired either at the inverter's AC connection or in the installation switchboard.

But when combination inverter/charger units are used, the MEN link is less straightforward. The inverter/charger unit has two different modes of operation:

- In inverter mode, it is operating as a standalone inverter and is the main power supply in the system.
- In charger mode, it will feed through grid or generator power into the system.

When the inverter/charger is inverting and acting as a power supply, it will have to make an independent MEN link. But when it is feeding through a generator or grid supply, the incoming supply has to have the MEN link instead of the inverter/charger.

Victron inverter/chargers contain an internal ground relay. This relay automatically makes or breaks the connection between earth and neutral. If this is not desired, this relay can be turned off in the inverter/charger settings. Note that if the relay is turned off, you will have to hard-wire a neutral-to-earth link in the system.

Likewise, in some installations, it might not be allowed to break the neutral conductor, in that case, provided an inverter/charger-II is used, choose a grid-code setting of a type that states that the AC neutral path is externally joined.

The inverter/charger is in charger mode and/or feed-through mode:

When the inverter is connected to AC power the AC input relay is closed and at the same time, the earth relay is open. The AC output system relies on the AC power supply to provide the neutral-to-earth link. This link is needed so the RCD in the AC output circuit is operational. Earth relay AC input relay

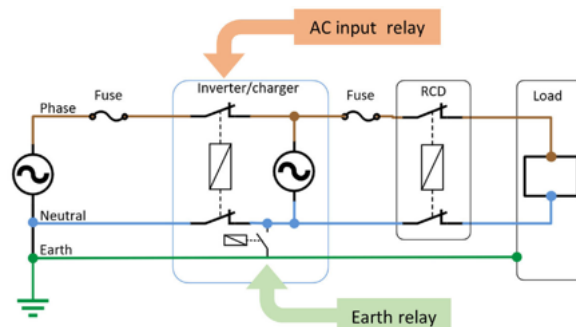

The Inverter/charger is in inverter mode:

When the AC power supply is disconnected, has been turned off, or has failed, the AC input relay opens. When the AC input relay is open, the installation does not have a neutral-to-earth link anymore. This is why at the same time the earth relay is closed. As soon as the earth relay closes the inverter/charger has made an internal neutral-to-earth link. This link is needed so the RCD in the AC output circuit is operational.

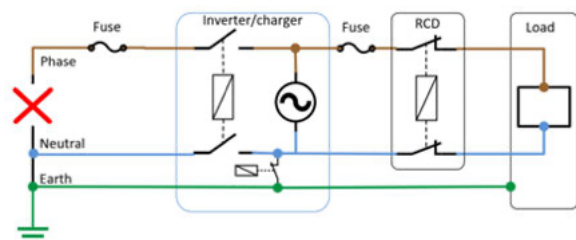

7.5. Mobile installations

A mobile installation is an installation that operates independently from the grid. When it connects to AC power, it usually connects to the grid at different locations and/or generators. For example, boats, vehicles or mobile backup power systems. In this chapter, a boat installation is used. However, this information can be used for any mobile installation.

A mobile system does not have an earth stake. So, something else in its place is needed to create a central earth potential. All touchable metal parts of the boat or vehicle must be connected to each other to create a local earth. Examples of metal parts in a boat or vehicle are: chassis, hull, metal fluid pipes, railing, engine, power socket earth contacts, lightning conductors and the earth plate (if present).

A mobile system typically connects to a variety of power sources. In these situations it is sometimes not clear which of the leads in the shore power supply is connected to earth or if the earth is connected at all. Also, phase and neutral may not have been wired correctly. Connecting a supply like this to a mobile system can potentially create a short circuit to earth. Or the earth is missing completely.

It also matters if the mobile system connects to power or if it is disconnected from power and running autonomously.

Some examples of different situations a mobile system can be in:

A boat is connected to shore power

When a boat is moored and connected to shore power installation is similar to a residential installation. There is only one difference; the boat does not have its own earth connection; like the earth spike you will find in a house.

The boat installation relies on the earth provided by the shore connection. Unfortunately, this earth is not always reliable due to the fact that the marina cables are often long and might have an insufficient cable core thickness. To create a safe situation, the metal parts of the boat, like the hull, will have to be connected to the incoming earth from the shore power cable. The shore power earth is connected to neutral.

If an earth leakage occurs, current will flow through the earth conductor in the mains cable, but also via the hull via the water and back to shore earth. Both earth leakage circuits have the same potential and are in a way connected in parallel. But more current will flow through the earth conductor in the shore cable. The RCD will still trigger an earth fault because it will compare phase current in versus current out via neutral.

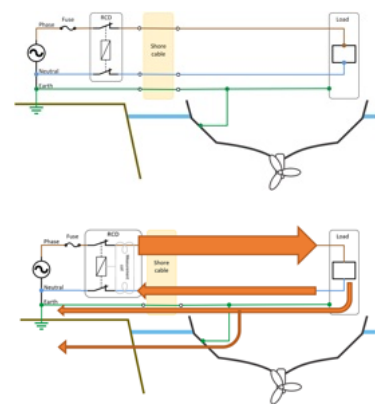

A boat is disconnected from shore power

As soon as the boat disconnects from shore power the entire installation changes because the installation is now not part of the grid anymore and the connection with neutral and earth are lost.

The installation is now the main power supply and together with the load forms its own autonomous electric circuit. No current will flow into the hull and into the water.

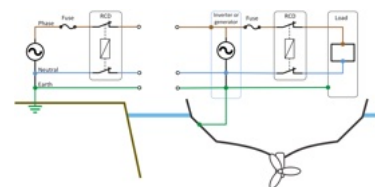

Floating network in boat or vehicle (IT Network)

In a mobile system where an inverter (or generator) is the only power source one can specifically choose not to use a TT network but to use an IT network. In an IT network, the phase and neutral are not coupled to another potential like earth. The voltages created by the independent power source are floating. A system like this is very safe and simple to install.

If a conductor or housing in this system is touched by a person, no current can flow to earth. Remember, for current to flow a complete circuit is needed. In this system the earthing conductor is absent, and the electric circuit to earth is not complete. This is a similar situation to the safety transformer in a bathroom.

Inverters and generators are in principle nothing more than the source of two potential differences with a difference of 230 Volt (or 120V). Touching will not lead to a current flow because the path is incomplete. It is the same as a bird sitting on an electricity wire.

Be aware that touching both the phase and neutral wire at the same time is always dangerous because then the path is complete.

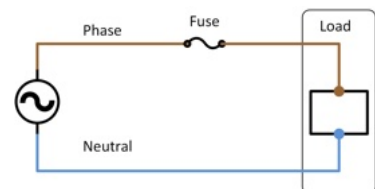

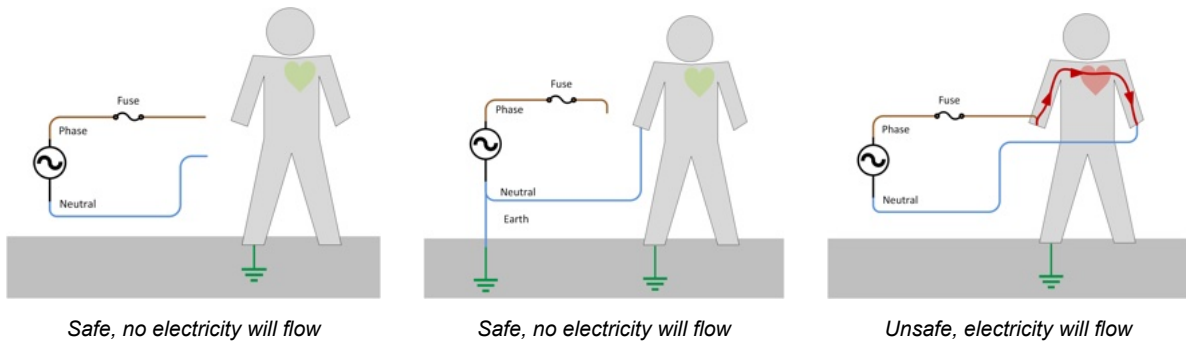

Mobile network with earth and neutral to earth link (TT network)

If the mobile system connects to the grid via a transfer switch or via an inverter/charger, earth and a neutral to earth link is introduced into the system. It becomes a TT network. This is also the case if local regulation requires that earth, and neutral to earth link and an RCD has been hardwired in a mobile system that contains an inverter or generator. The moment this happens the system will become more dangerous, so as soon as earth and a neutral to earth link have been added to a system an RCD will need to be installed. as to satisfy the requirements of the TT or TN network where the mobile network is now connected to.

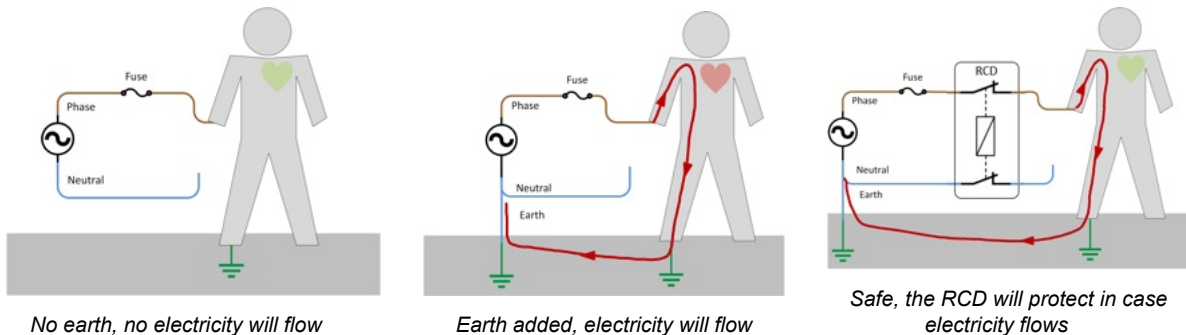

From IT network to TT network

With a mobile system, it is possible to create a network that is a TT network when connected to mains and at the same time become a floating IT network when the grid is disconnected and a generator or inverter is in use. This is something that is not desired and should be avoided.

When an installation disconnects from the grid, it also disconnects from the grid earth. If the mobile installation does not have earth and also no earth and neutral link it will become a floating system the moment the grid is disconnected.

Although the system might have an RCD, the RCD cannot detect an earth leakage current anymore because the Neutral is not connected to earth.

Pressing the test button on the RCD is useless if the neutral-to-earth link is missing. When you press the test button, you will get a false impression that the RCD is operational, while in reality, the RCD will not operate in case of an earth fault as the neutral-to-earth link is missing. When the test button on an RCD is pressed, an internal bypass is activated, simulating an earth leak, so the RCD can be electrically and mechanically tested. The test button, by no means, is a test for the whole installation. It only tests the RCD itself. This will lead to confusion and/or dangerous situations. It is for these reasons that it is recommended to always follow the principles of the TT network, also for situations when the installation is not connected to mains power.

The switch from IT to TT network has to accommodate for a connection being made between neutral and mobile system earth as soon as the grid is disconnected. This can be done automatically by an inverter/charger with an earth relay or must be hard-wired into a transfer switch. Not all inverters and generators have a neutral that is connected to earth. This will always need to be checked prior to installation. And if needed a neutral-to-earth link needs to be hard-wired

7.6. Isolation and grounding of Victron equipment

This chapter explains the isolation of a variety of Victron products between AC and DC, or between DC and DC. This information is needed so a system containing a Victron product can be grounded correctly.

Isolation of all Victron inverters and inverter/chargers:

- Between the AC circuitry and chassis: basic isolation. The chassis therefore must be grounded.
- Between AC and DC: reinforced isolation. Once the chassis has been grounded the DC is therefore considered safe to touch if the nominal voltage is 28V or lower.
- Between the DC circuitry and chassis: basic isolation. Therefore, DC negative or positive grounding is allowed.

In the case of positive grounding, non-isolated interface connections will refer to the DC negative and not to ground. Grounding such a connection will damage the product. The AC ground terminal of all inverters and inverter/chargers is connected to the chassis.

AC neutral grounding of Victron inverters

The neutral of all inverters rated 1600VA and above and the Phoenix Inverter Compact 1200VA is connected to the chassis. Grounding the chassis will therefore also ground the AC neutral. A grounded neutral is required for the proper operation of an RCD (or RCCB, RCBO or GFCI).

If no reliable ground is available and/or if an RCD (or RCCB, RCBO or GFCI) is not installed, the AC neutral to chassis connection should be removed to improve safety. Warning: such an installation does probably not comply with local regulations.

The AC neutral of lower power inverters is generally not connected to the chassis. A neutral-to-ground connection can be established, however: please see the product manual.

AC neutral grounding of Victron inverter/chargers

The output AC neutral of all inverter/chargers is connected to the input AC neutral when the back-feed relays are closed (AC available on input). When the back-feed relays are open, a ground relay connects the outgoing neutral to the chassis. A grounded neutral is required for the proper operation of an RCD. Disabling the ground relay is possible on most models. Please see the product manual.

Isolation of MPPT solar chargers

There is no isolation between PV input and DC output. There is basic isolation between input/output and chassis.

Isolation of other products

Battery chargers: reinforced isolation between AC and DC. Basic Isolation between AC and chassis, except for the Smart IP65 chargers which have reinforced isolation between AC and the plastic casing. DC-DC converters, diode and FET splitters and other DC products: the casing is always isolated from the DC (basic isolation).

7.7. System grounding

Thus far we discussed AC earth or ground in AC installations, but grounding is also needed for the DC components in an installation. This chapter describes some common installations that contain not only an inverter/charger but also a battery bank, solar charger and a PV array.

Off-grid system grounding

Do not ground the positive or negative of the PV array. The PV negative input of the MPPT is not isolated from the negative output. Grounding the PV will therefore result in ground currents. The PV frames however may be grounded, either close to the PV array or (preferably) to the central ground. This will provide some protection against lightning.

Ground close to the battery. The battery poles are supposed to be safe to touch. The battery ground should therefore be the most reliable and visible ground connection.

The DC ground cabling should have a sufficient thickness to be able to carry a fault current at least equal to the DC fuse rating.

The chassis of the inverter or Multi/Quattro must be grounded. There is basic insulation between AC and chassis. The chassis of the MPPT solar charger must be grounded. There is basic insulation between AC and chassis.

Please note that the AC distribution with fuses or MCBs and PV array and PV frame grounding are not shown.

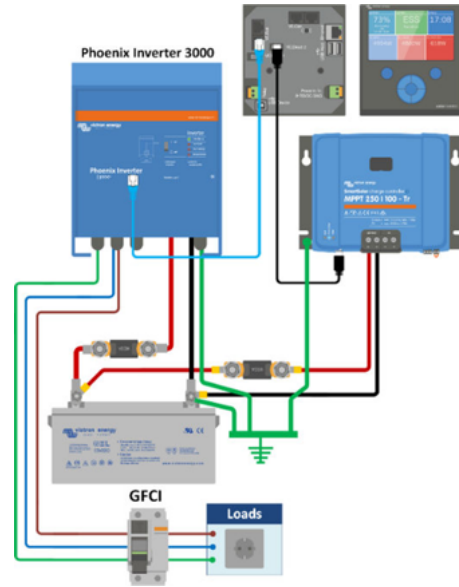

Off-grid with generator

Use one ground only, close to the battery. The battery poles are supposed to be safe to touch. The battery ground should therefore be the most reliable and visible ground connection.

The DC ground cabling should have a sufficient thickness to be able to carry a fault current at least equal to the DC fuse rating.

Similarly, AC ground cabling should be able to carry a fault current at least equal to the AC fuse rating.

A GFCI will be functional only if the chassis of the Multi/Quattro is grounded.

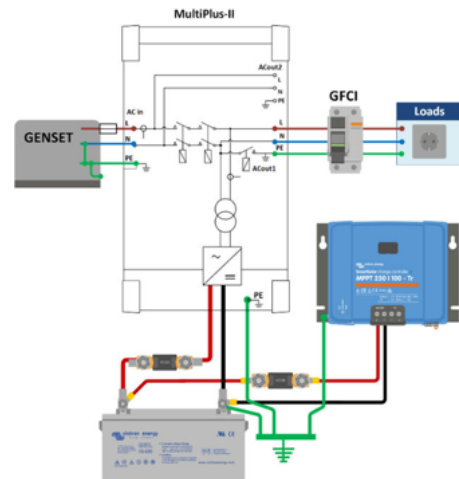

Off-grid with high power generator

Ground the generator directly at the central ground.

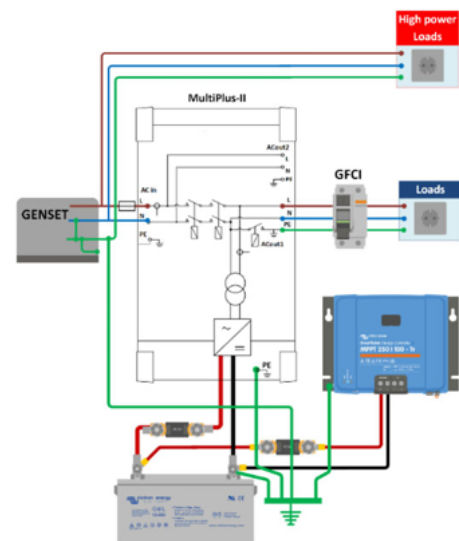

Grid-connected Energy Storage System (ESS)

The DC ground cabling should be able to carry a fault current at least equal to the DC fuse rating.

Connect the chassis of the inverter/charger to the ground busbar

The AC-out ground may be taken from the central busbar or from the AC-out terminal.

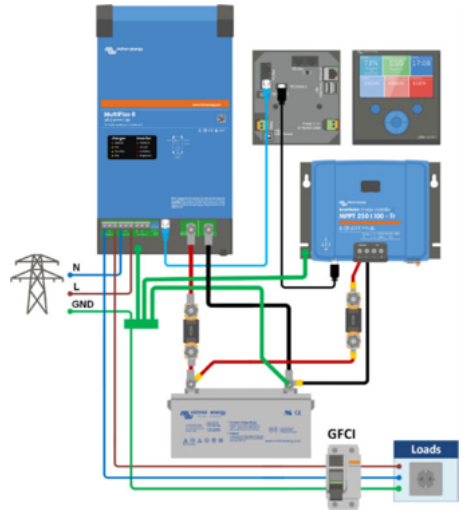

8. Galvanic corrosion

Galvanic corrosion is caused by an electric current that enters a boat via the shore power earth wire and returns back to shore via the water. These currents can cause corrosion to the boat's underwater metals, like the hull, propeller, shaft and so on. This current is called galvanic current.

Galvanic current is a DC current. It is caused by the natural voltage difference between metals. A galvanic current can only exist when there is a closed electric circuit. A conductor belonging to another electric circuit can be part of the galvanic corrosion circuit. If a boat with a metal hull is near the shore a natural voltage difference of 0.1 - 1 Vdc exists between the hull and the water.

This potential difference leads to nothing as long there is no completion of the electric circuit. But, as soon as shore power is connected to the boat, the shore earth is automatically connected to the boat's hull and the electric circuit is complete. Now the following circuit is made: hull - water - shore - earth spike - earth wire - hull. A galvanic current will flow through this circuit. The galvanic current partly runs through the AC circuit but is not related to that circuit. Current will continue to flow until the potential difference is eliminated. The height of the current depends on the resistance of the electric circuit. The resistance is determined by factors like the length of the shore power cable and local earth spreading resistance.

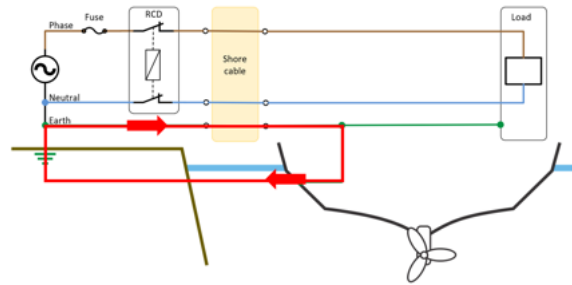

Chemically speaking, the "weakest" metal in the galvanic circuit will be the quickest to submit its molecules to keep the current going. If the hull of the ship is part of the galvanic circuit and the hull contains the weakest metal, the hull will start to corrode over time. This can develop into a nasty situation and it can become quite expensive and unsafe if left unchecked. There are known cases of ships that have sunk due to galvanic corrosion. Aluminium hulls are notoriously susceptible to this kind of corrosion. Galvanic corrosion can also exist between the different metals that are attached to a boat, like the propeller, the motor, the hull and so on. All these parts are connected to earth and therefore additional small currents will run between these parts. This is the reason sacrificial anodes are mounted. A sacrificial anode is a piece of metal that is weaker than the metal around it. Therefore, they are sacrificed in order to protect the other metals. They can only prevent corrosion by postponing it. What type of sacrificial anode to use, depends on the type of metal it protects and what type of water the boat is in. It is recommended to regularly check these anodes.

8.1. Preventing galvanic corrosion

The answer to prevention is quite simple. To prevent corrosion the electric circuit must be broken. Although this is nearly impossible to achieve with the small circuits between the different metals attached to the boat, it is achievable with the shore power connection.

The easiest way to break this circuit is to not connect the shore earth to the hull. However, this is unsafe and not recommended, because this results in the hull being not sufficiently earthed and therefore satisfactory working of the RCD cannot be guaranteed anymore, leading to unsafe situations on board. There are safe ways to prevent galvanic corrosion without compromising safety. This can be achieved by using a galvanic isolator or by using an isolation transformer.

8.2. The galvanic isolator

The galvanic isolator prevents galvanic corrosion. It blocks the low-voltage DC currents that enter your boat via the shore power earth wire. These currents can cause corrosion to the boat's underwater metals, like the hull, propeller, shaft and so on.

The galvanic isolator consists of two diodes connected in antiparallel. The galvanic isolator is connected between the shore earth connection and the central earth point in the boat.

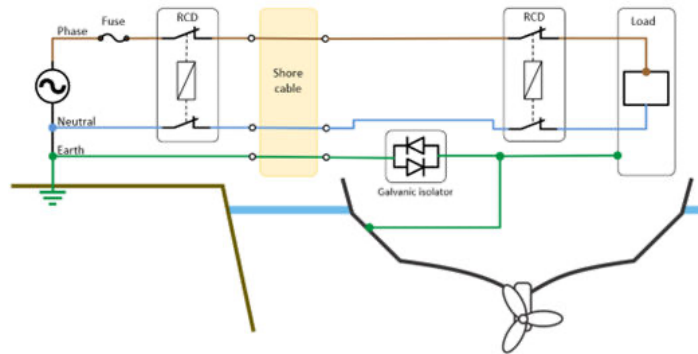

The diodes in this configuration conduct electricity in both directions only when a certain threshold voltage is reached. The threshold voltage is approximately 1.4 Vdc. The threshold voltage is higher than the galvanic potential difference between the various metals. In this way, no galvanic current can run. On the other hand, a higher earth fault voltage in the AC circuit will be allowed to pass through enabling the full functioning of a connected RCD.

The advantage of the galvanic isolator is its low weight and size, the disadvantage is that this unit relies on a good earth conductor. Another consideration is that galvanic corrosion can also take place through the neutral conductor, this in cases where the neutral conductor has been connected to earth through one of the electrical appliances on board, like a suppression filter or other appliances.

8.3. The isolation transformer

A better solution to stop galvanic corrosion is the use of an isolation transformer. In an isolation transformer, the incoming electricity is changed into electromagnetism and then changed back again into electricity.

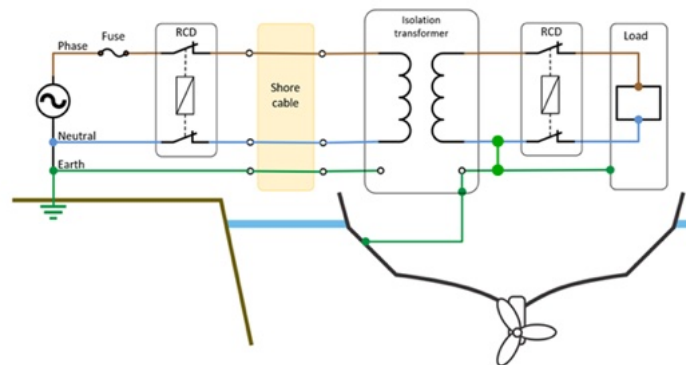

The input and output are completely isolated and will break the electric circuit between star point - earth conductor - hull - water - star point, thus effectively blocking a galvanic current. Another feature of the isolation transformer is that electrically speaking it is an electricity source, fed by another electricity source. On the output side of the transformer, one of the outgoing phases is connected to the hull, thereby, creating a phase, neutral and earth, thus guaranteeing a correct functioning of an RCD.

An isolation transformer will give the same safety as in a house installation and more. The installation is also completely isolated of electrical problems of surrounding boats. An added benefit is that an isolation transformer is quite often able to raise or lower the incoming shore voltage. This can be useful when a 230Vac boat has to connect to a 120Vac supply, or vice versa.

9. Credits

Author:

Margreet Leeftink

With thanks to:

Reinout Vader, the [Victron community](#) and especially Mike Riley and the World wide web.

Content credits:

Fuse speed information: https://www.swe-check.com.au/pages/learn_fuse_markings.php

Bussmann: http://www.cooperindustries.com/content/public/en/bussmann/transportation/products/circuit_protection/fuses/marine_rated_batteryfuses.html

Dangers of electricity: https://www.hsa.ie/eng/Topics/Electricity/Dangers_of_Electricity/

Cable interference and shielding: <https://www.multicable.com/resources/reference-data/signal-interference-and-cable-shielding/>

Image Ohm's law cartoon: <https://www.clipart.email/download/4165420.html>

Image ohm's law formula wheel: <https://www.esdsite.nl/elektronica/formules/wetvanohm.html>

Thermal magnetic circuit breaker image: <https://electrical-engineering-portal.com/how-circuit-breaker-trip-unit-works>

Image tinned copper busbar: <https://au.rs-online.com/web/p/din-rail-terminal-accessories/4895420/>

Blade fuses: https://commons.wikimedia.org/wiki/File:Electrical_fuses,_blade_type.svg

RS pro crimping tool: <https://au.rs-online.com/web/>

NMEA2000 cable image: <https://www.powerandmotoryacht.com/electronics/down-wire>

Wikipedia page on lightning: <https://en.wikipedia.org/wiki/Lightning>